



LIDES
LIGHT IN DESIGN

Exterior lighting 2023





Founded in 2012, LIDES aims to furnish the market with elaborately detailed and high-quality lighting that meets demands from the most discerning customers.

The lighting is designed with an emphasis on functionality, to light up the space as needed and enable control compatible with modern technologies available on the market.

A beautiful design element in and of themselves, the lights serve as the main source of illumination while allowing for adjustable brightness to lend the space an atmospheric and relaxed ambiance.

Our assortment combines the beauty of glass and light, art and modern technology, resulting in a unique and unforgettable experience.

In addition to glass, our fixtures incorporate other high-quality materials such as metals with one-of-a-kind surface finishes and uniquely cut Swarovski® crystals.

We provide post-warranty service and renovation for all our products.

Where tradition meets innovation.

A fusion of art and functionality.

A new way of looking at light.

A unique design.

Hand-blown glass lamps

that add character to any space.



Ocean



Clean design

Beauty of the hand-blown glass stands out in clean lines of the lighting. Air bubbles caught in the glass subtly reflect the light into space and create a pleasant evening atmosphere. With its design, Ocean is the jewel of any space, even in daylight.

Resilience

The Ocean collection combines the mastery of glass craftsmanship with high-quality design and first-class materials, such as stainless steel. Maintenance is easy and individual parts can be refurbished.

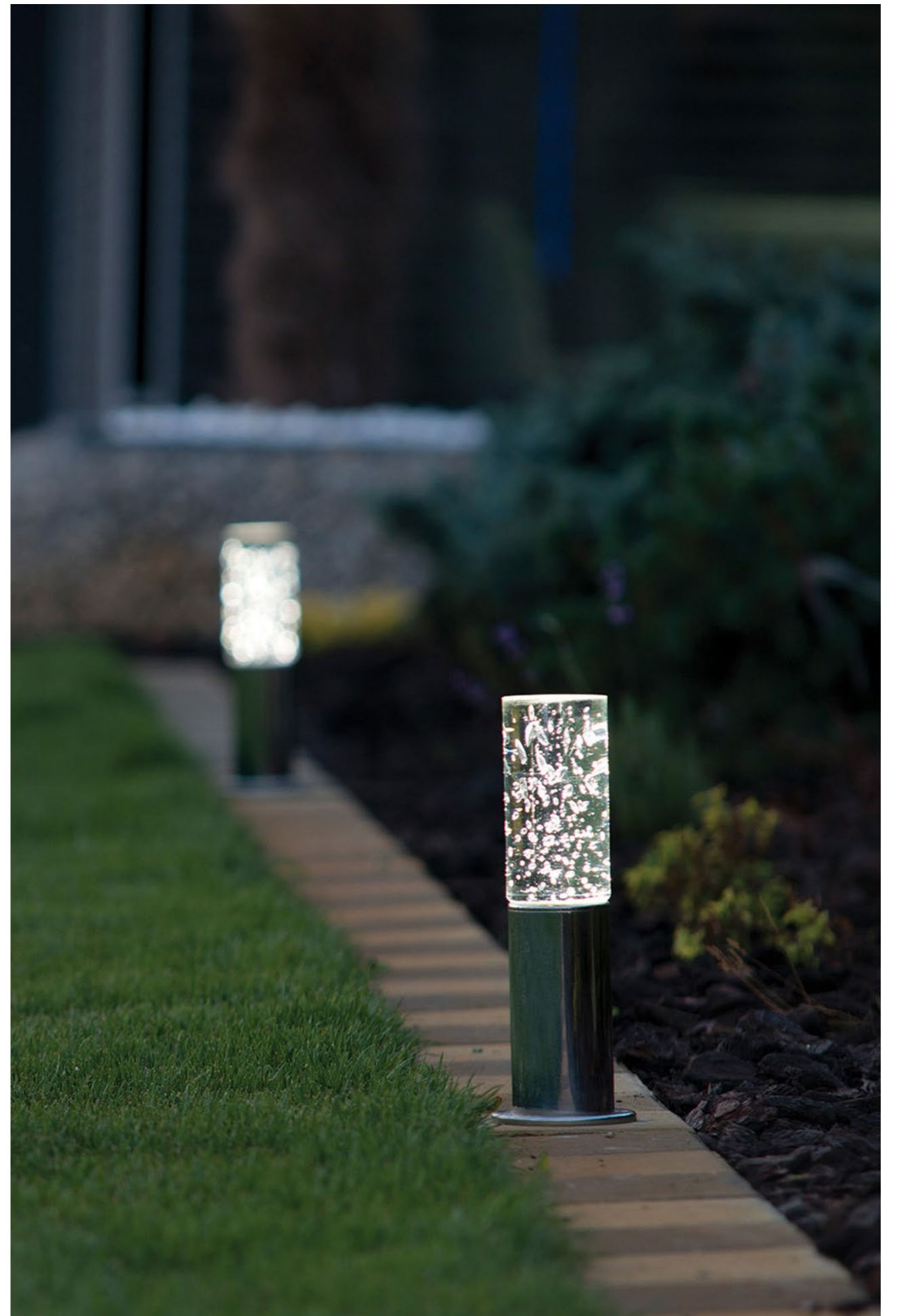



Ocean collection

The glass shade and stainless steel base are available in several heights for variety.

This create space for their variable use.

Lamps can be used as line lighting for sidewalks or as garden lighting with an irregular layout.

We recommend groups of 2 to 3 lamps in different heights.

Lamps are fixed to solid bases.

Ocean 30

bollard lamp | exterior

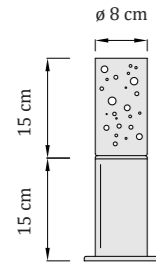

Light source

Input voltage 24V DC:

16W LED brand CREE
3000K
4000K
6000K
RGBW
dimmable (control not included)
power supply not included

Input voltage 230V AC / 50-60 Hz:

9W LED brand SEOUL
3000K
4000K
6000K
non-dimmable

Code

- Warm white: OC-24-WW30
- Natural white: OC-24-NW30
- Cool white: OC-24-CW30
- RGBW: OC-24-RGBW30

- Warm white: OC-230-WW30
- Natural white: OC-230-NW30
- Cool white: OC-230-CW30

material: stainless steel | glass weight: 3,7 kg

CE UKCA IP65 24V DC / 230V AC

Ocean 45

bollard lamp | exterior

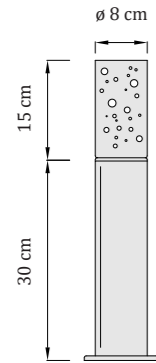

Light source

Input voltage 24V DC:

16W LED brand CREE
3000K
4000K
6000K
RGBW
dimmable (control not included)
power supply not included

Input voltage 230V AC / 50-60 Hz:

9W LED brand SEOUL
3000K
4000K
6000K
non-dimmable

Code

- Teplá biela: OC-24-WW45
- Natural white: OC-24-NW45
- Cool white: OC-24-CW45
- RGBW: OC-24-RGBW45

- Warm white: OC-230-WW45
- Natural white: OC-230-NW45
- Cool white: OC-230-CW45

material: stainless steel | glass weight: 4 kg

CE UKCA IP65 24V DC / 230V AC

Ocean 60

bollard lamp | exterior

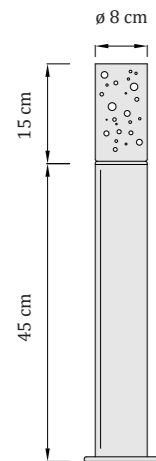

Light source

Input voltage 24V DC:

16W LED brand CREE
3000K
4000K
6000K
RGBW
dimmable (control not included)
power supply not included

Input voltage 230V AC / 50-60 Hz:

9W LED brand SEOUL
3000K
4000K
6000K
non-dimmable

Code

- Warm white: OC-24-WW60
- Natural white: OC-24-NW60
- Cool white: OC-24-CW60
- RGBW: OC-24-RGBW60

- Warm white: OC-230-WW60
- Natural white: OC-230-NW60
- Cool white: OC-230-CW60

material: stainless steel | glass weight: 4,5 kg

CE UKCA IP65 24V DC / 230V AC

Ocean 40

bollard lamp | exterior

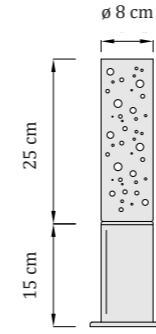

Light source

Input voltage 24V DC:

16W LED brand CREE
3000K
4000K
6000K
RGBW
dimmable (control not included)
power supply not included

Input voltage 230V AC / 50-60 Hz:

9W LED brand SEOUL
3000K
4000K
6000K
non-dimmable

Code

- Warm white: OC-24-WW40
- Natural white: OC-24-NW40
- Cool white: OC-24-CW40
- RGBW: OC-24-RGBW40

- Warm white: OC-230-WW40
- Natural white: OC-230-NW40
- Cool white: OC-230-CW40

material: stainless steel | glass weight: 4,8 kg

CE UKCA IP65 24V DC / 230V AC

Ocean 55

bollard lamp | exterior

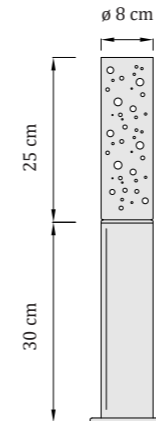

Light source

Input voltage 24V DC:

16W LED brand CREE
3000K
4000K
6000K
RGBW
dimmable (control not included)
power supply not included

Input voltage 230V AC / 50-60 Hz:

9W LED brand SEOUL
3000K
4000K
6000K
non-dimmable

Code

- Warm white: OC-24-WW55
- Natural white: OC-24-NW55
- Cool white: OC-24-CW55
- RGBW: OC-24-RGBW55

- Warm white: OC-230-WW55
- Natural white: OC-230-NW55
- Cool white: OC-230-CW55

material: stainless steel | glass weight: 5,2 kg

CE UKCA IP65 24V DC / 230V AC

Ocean 70

bollard lamp | exterior

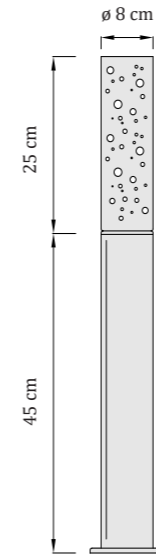

Light source

Input voltage 24V DC:

16W LED brand CREE
3000K
4000K
6000K
RGBW
dimmable (control not included)
power supply not included

Input voltage 230V AC / 50-60 Hz:

9W LED brand SEOUL
3000K
4000K
6000K
non-dimmable

Code

- Warm white: OC-24-WW70
- Natural white: OC-24-NW70
- Cool white: OC-24-CW70
- RGBW: OC-24-RGBW70

- Warm white: OC-230-WW70
- Natural white: OC-230-NW70
- Cool white: OC-230-CW70

material: stainless steel | glass weight: 5,6 kg

CE UKCA IP65 24V DC / 230V AC



Ocean Art

hand-forged exterior lamp

Ocean Art embodies the precise work of a blacksmith's craft and, combined with its crystal clear glass, can grace any garden as an artistic piece.

A patina is applied to the surface of the lamp, which makes for a unique appearance with a rustic touch. Thanks to the blacksmith work, the lamp fits with even more lavish spaces perfectly.



Ocean Art 35

bollard lamp | exterior

operating temperature: - 30 to 60 °C

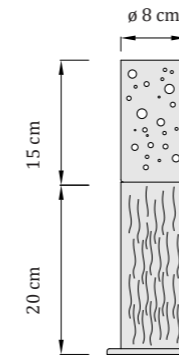

material: stainless steel | glass

weight: 4,5 kg



UKCA

IP65

24V DC / 230V AC

Light source

Code

Input voltage 24V DC:

16W LED brand CREE
3000K
4000K
6000K
RGBW
dimmable (control not included)
power supply not included

- Warm white: OCA-24-WW35
- Natural white: OCA-24-NW35
- Cool white: OCA-24-CW35
- RGBW: OCA-24-RGBW35

Input voltage 230V AC / 50-60 Hz:

9W LED brand SEOUL
3000K
4000K
6000K
non-dimmable

- Warm white: OCA-230-WW35
- Natural white: OCA-230-NW35
- Cool white: OCA-230-CW35

Ocean Art 45

bollard lamp | exterior

operating temperature: - 30 to 60 °C

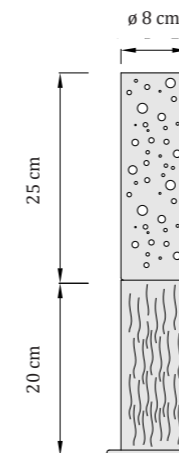

material: stainless steel | glass

weight: 5,7 kg



UKCA

IP65

24V DC / 230V AC

Light source

Code

Input voltage 24V DC:

16W LED brand CREE
3000K
4000K
6000K
RGBW
dimmable (control not included)
power supply not included

- Warm white: OCA-24-WW45
- Natural white: OCA-24-NW45
- Cool white: OCA-24-CW45
- RGBW: OCA-24-RGBW45

Input voltage 230V AC / 50-60 Hz:

9W LED brand SEOUL
3000K
4000K
6000K
non-dimmable

- Warm white: OCA-230-WW45
- Natural white: OCA-230-NW45
- Cool white: OCA-230-CW45

Ocean Wall

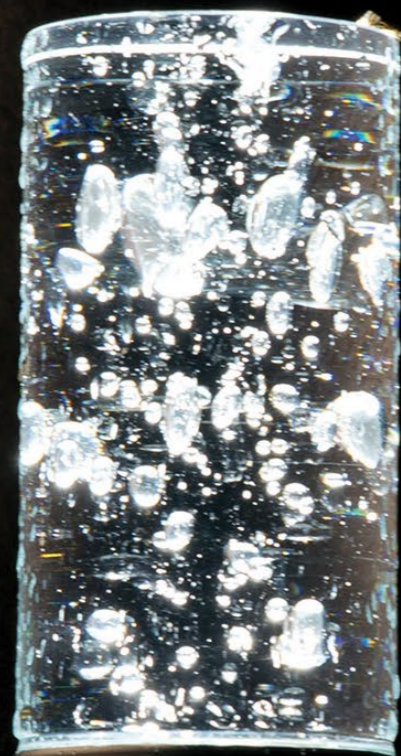

Wall lamp made of hand-blown glass

An elegant outdoor lamp that will stand out also in modern interiors. Suitable for high-humidity environments such as spa and wellness areas.

Air bubbles trapped in the shade of crystal clear glass refract the light beautifully. As a result, the light casts impressive irregular rays on the wall.



Ocean Wall

wall lamp | exterior | interior

operating temperature: - 30 to 60 °C

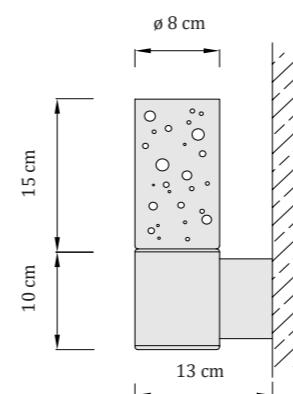

Light source

Input voltage 24V DC:
 16W LED brand CREE
 3000K
 4000K
 6000K
 RGBW
 dimmable (control not included)
 power supply not included

Input voltage 230V AC / 50-60 Hz:
 9W LED brand SEOUL
 3000K
 4000K
 6000K
 non-dimmable

Code

● Warm white: OW-24-WW
 ● Natural white: OW-24-NW
 ● Cool white: OW-24-CW
 ● RGBW: OW-24-RGBW

● Warm white: OW-230-WW
 ● Natural white: OW-230-NW
 ● Cool white: OW-230-CW

material: stainless steel | glass

weight: 3,7 kg

CE

UKCA

IP65

24V DC / 230V AC



Ocean Wall Art

hand-forged exterior lamp

The lamp is made of hand-blown glass and a hand-forged stainless steel body. A patina is applied to the surface of the light, which gives the light a one-of-a-kind appearance with a rustic touch.

Light refracts off air bubbles captured in the shade of crystal clear glass, creating gorgeous shadow play on the wall.



Ocean Wall Art

wall lamp | exterior | interior

operating temperature: - 30 to 60 °C

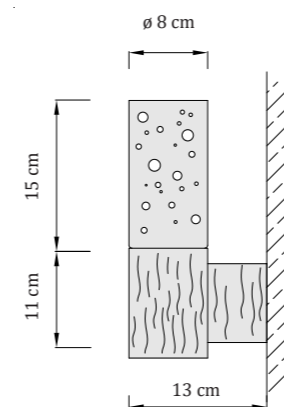

material: stainless steel | glass weight: 3,7 kg

Light source

Input voltage 24V DC:
 16W LED brand CREE
 3000K
 4000K
 6000K
 RGBW
 dimmable (control not included)
 power supply not included

Input voltage 230V AC / 50-60 Hz:
 9W LED brand SEOUL
 3000K
 4000K
 6000K
 non-dimmable

Code

● Warm white: OWA-24-WW
 ● Natural white: OWA-24-NW
 ○ Cool white: OWA-24-CW
 ● RGBW: OWA-24-RGBW

● Warm white: OWA-230-WW
 ● Natural white: OWA-230-NW
 ○ Cool white: OWA-230-CW

CE UKCA IP65 24V DC / 230V AC

RAY



Exterior lamp made of polished stainless steel

An ideal solution for highlighting the beauty of any garden at night, Ray spotlights are great for emphasizing individual elements such as trees, bushes, flower beds or special architectural features.

Beam lighting can also be used to create a sense of security and safety around the grounds of the house by illuminating dark areas.



Beam angle

15°

40°

RAY lamps are adjustable in all directions.
They are anchored to the soil using a metal spike or to solid materials using an anchor bolt.

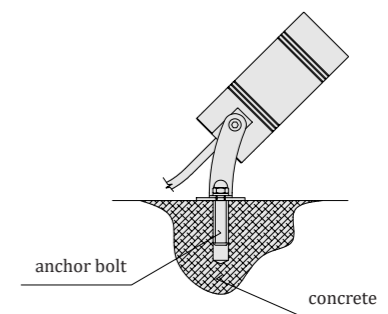
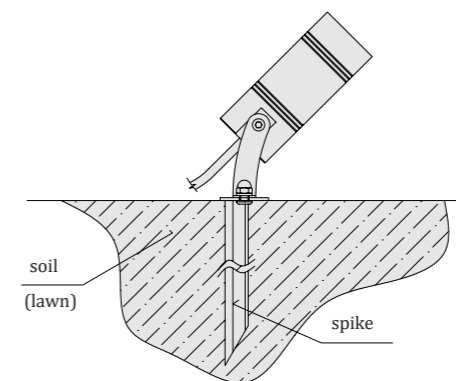



Ray

spotlight fixture | exterior

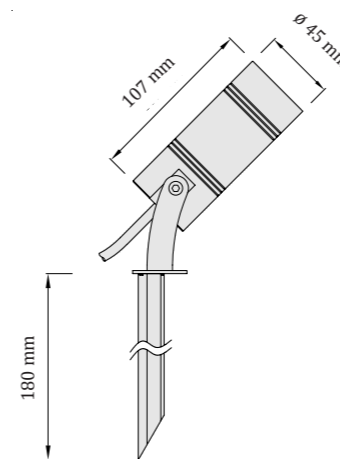

material: stainless steel

weight: 0,9 kg

Light source

Input voltage 24V DC:
6W LED brand CREE
3000K
4000K
6000K
dimmable (control not included)
power supply not included

Code

15° optics

- Warm white: RA-24-WW-15
- Natural white: RA-24-NW-15
- Cool white: RA-24-CW-15

40° optics

- Warm white: RA-24-WW-40
- Natural white: RA-24-NW-40
- Cool white: RA-24-CW-40

Light source

Input voltage 230V AC / 50-60 Hz:
3W LED brand CREE
3000K
4000K
6000K
non-dimmable

Code

15° optics

- Warm white: RA-230-WW-15
- Natural white: RA-230-NW-15
- Cool white: RA-230-CW-15

40° optics

- Warm white: RA-230-WW-40
- Natural white: RA-230-NW-40
- Cool white: RA-230-CW-40



UKCA

IP65

24V DC / 230V AC



LIDES s.r.o.
no. 1907, 951 32 Horna Kralova
Slovakia

www.lides.com
lides@lides.sk

