



LIDES

LIGHT IN DESIGN

Interior lighting 2023



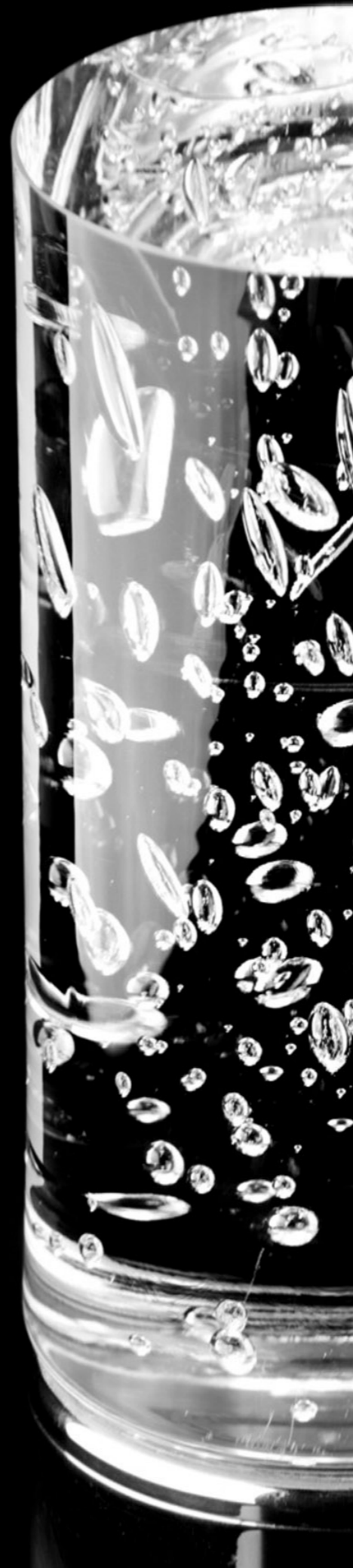

Founded in 2012, LIDES aims to furnish the market with elaborately detailed and high-quality lighting that meets demands from the most discerning customers.

The lighting is designed with an emphasis on functionality, to light up the space as needed and enable control compatible with modern technologies available on the market.

A beautiful design element in and of themselves, the lights serve as the main source of illumination while allowing for adjustable brightness to lend the space an atmospheric and relaxed ambiance.

Our assortment combines the beauty of glass and light, art and modern technology, resulting in a unique and unforgettable experience.

In addition to glass, our fixtures incorporate other high-quality materials such as metals with one-of-a-kind surface finishes and uniquely cut Swarovski® crystals.

We provide post-warranty service and renovation for all our products.

Where tradition meets innovation.

A fusion of art and functionality.

A new way of looking at light.

A unique design.

Hand-blown glass lamps

that add character to any space.



Ocean Up



Ceiling lamp crafted of hand-blown glass

The Ocean collection was inspired by the unbridled quality of water element.

The churning water is represented by air bubbles trapped within glass.

Hand-blown glass crafting is an art form that requires a lot of skill and attention to detail, thus making each piece an original work of art.

Ideal for spa and wellness areas

The Ocean Up was designed especially for spas and saunas.

However, it will prove its worth also in spaces such as corridors,

bathrooms, and suspended ceilings in exteriors.

Ocean Up is available in several colors of emitted light. It is the cool white

version that brings out the beauty of the glass shade most, though.



TIP: Use a combination of lamps of different heights irregularly distributed within the space: 1 to 2 lamps per 1 m².

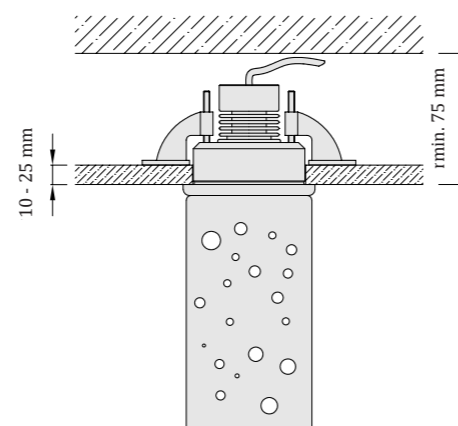

Ocean Up 30

ceiling lamp recessed
interior | SPA | saunas | exterior ceilings
operating temperature: - 30 to 120 °C

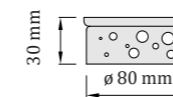

Light source

- Warm white: 6W LED, CREE | 3000 K
- Natural white: 6W LED, CREE | 4000 K
- Cool white: 6W LED, CREE | 6000 K
- RGB: 5W LED, CREE

Code

OU1-12-WW30
OU1-12-NW30
OU1-12-CW30
OU1-12-RGB30

dimmable (control not included)
power supply not included

material: stainless steel | glass

weight: 0,9 kg

CE

UKCA

IP65

12V DC

Ocean Up 50

ceiling lamp recessed
interior | SPA | saunas | exterior ceilings
operating temperature: - 30 to 120 °C

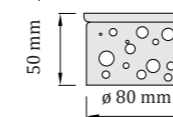

Light source

- Warm white: 6W LED, CREE | 3000 K
- Natural white: 6W LED, CREE | 4000 K
- Cool white: 6W LED, CREE | 6000 K
- RGB: 5W LED, CREE

Code

OU1-12-WW50
OU1-12-NW50
OU1-12-CW50
OU1-12-RGB50

dimmable (control not included)
power supply not included

material: stainless steel | glass

weight: 1,2 kg

CE

UKCA

IP65

12V DC

Ocean Up 100

ceiling lamp recessed
interior | SPA | saunas | exterior ceilings
operating temperature: - 30 to 120 °C

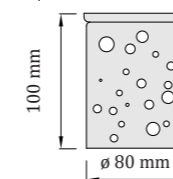

Light source

- Warm white: 6W LED, CREE | 3000 K
- Natural white: 6W LED, CREE | 4000 K
- Cool white: 6W LED, CREE | 6000 K
- RGB: 5W LED, CREE

Code

OU1-12-WW100
OU1-12-NW100
OU1-12-CW100
OU1-12-RGB100

dimmable (control not included)
power supply not included

material: stainless steel | glass

weight: 1,8 kg

CE

UKCA

IP65

12V DC

Ocean Up 150

ceiling lamp recessed
interior | SPA | saunas | exterior ceilings
operating temperature: - 30 to 120 °C

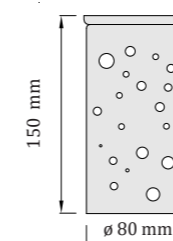

Light source

- Warm white: 6W LED, CREE | 3000 K
- Natural white: 6W LED, CREE | 4000 K
- Cool white: 6W LED, CREE | 6000 K
- RGB: 5W LED, CREE

Code

OU1-12-WW150
OU1-12-NW150
OU1-12-CW150
OU1-12-RGB150

dimmable (control not included)
power supply not included

material: stainless steel | glass

weight: 2,3 kg

CE

UKCA

IP65

12V DC



Fagus

Recessed stainless steel lamp

The Fagus is intended for installation in the ceilings of houses and other outdoor objects. However, it fits modern interiors too, suitable for lighting high-humidity spaces such as bathrooms or spas.

The lamp comes equipped with a diffused polycarbonate visor with a 180° radiation angle and a cover in 3 versions – polished stainless steel, golden gloss and white matt.

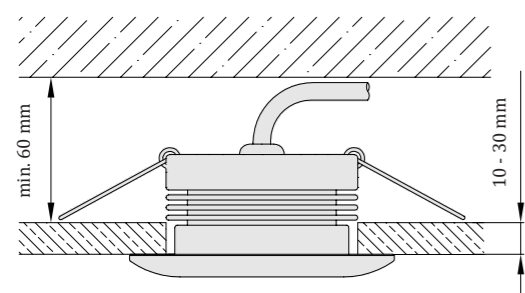

Surface finish

-  polished stainless steel
-  golden gloss
-  white matt



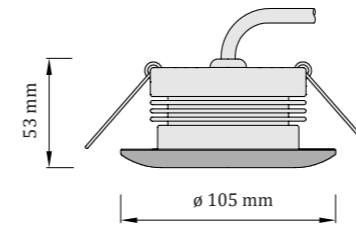

Fagus

polished stainless steel

ceiling lamp, recessed
interior | SPA | saunas | exterior ceilings
operating temperature: - 30 to 120 °C



Light source

-  Warm white: 11W LED brand LG | 3000 K
-  Natural white: 11W LED brand LG | 4000 K
-  Cool white: 11W LED brand LG | 6000 K
-  RGB: 11W LED brand CREE
-  RGBW: 16W LED brand CREE

Code

- FAG-24-11-WW
- FAG-24-11-NW
- FAG-24-11-CW
- FAG-24-11-RGB
- FAG-24-16-RGBW

dimmable (control not included)
power supply not included

material: aluminium + stainless steel weight: 0,6 kg

CE UKCA IP65 24V DC



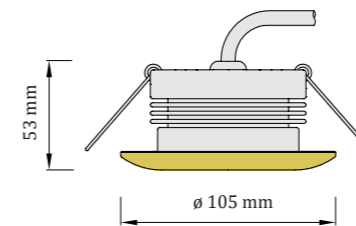

Fagus

golden gloss

ceiling lamp recessed
interior | SPA | saunas | exterior ceilings
operating temperature: - 30 to 120 °C



Light source

-  Warm white: 11W LED brand LG | 3000 K
-  Natural white: 11W LED brand LG | 4000 K
-  Cool white: 11W LED brand LG | 6000 K
-  RGB: 11W LED brand CREE
-  RGBW: 16W LED brand CREE

Code

- FAG-24-11-WW-G
- FAG-24-11-NW-G
- FAG-24-11-CW-G
- FAG-24-11-RGB-G
- FAG-24-16-RGBW-G

dimmable (control not included)
power supply not included

material: aluminium + stainless steel weight: 0,6 kg

CE UKCA IP65 24V DC



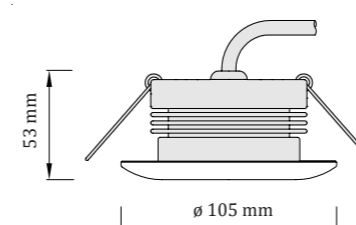

Fagus

white matt

ceiling lamp recessed
interior | SPA | saunas | exterior ceilings
operating temperature: - 30 to 120 °C



Light source

-  Warm white: 11W LED brand LG | 3000 K
-  Natural white: 11W LED brand LG | 4000 K
-  Cool white: 11W LED brand LG | 6000 K
-  RGB: 11W LED brand CREE
-  RGBW: 16W LED brand CREE

Code

- FAG-24-11-WW-W
- FAG-24-11-NW-W
- FAG-24-11-CW-W
- FAG-24-11-RGB-W
- FAG-24-16-RGBW-W

dimmable (control not included)
power supply not included

material: aluminium weight: 0,5 kg

CE UKCA IP65 24V DC



Dian



Stainless steel spotlight fixture

The main features of the Dian lamp are small dimensions and high luminosity relative to its size.

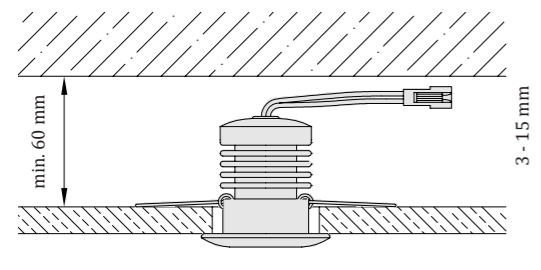
There are 2 light angles to choose from – 15° and 40°. Due to its narrow light beam, Dian is suitable for places that can benefit from its minimalist design or it can be used to highlight special design parts of the interior.



Surface finish

-  polished stainless steel
-  golden gloss
-  white matt

Dian

polished stainless steel



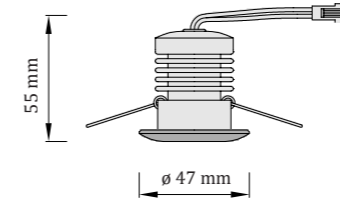



spotlight fixture | interior
operating temperature: - 20 to 60 °C



Light source

6W LED brand CREE (built in)
3000K
4000K
6000K
dimmable (control not included)
power supply not included

Code

- | | |
|------------|---|
| 15° optics |  Warm white: DIAN-WW-15 |
| |  Natural white: DIAN-NW-15 |
| |  Cool white: DIAN-CW-15 |
| 40° optics |  Warm white: DIAN-WW-40 |
| |  Natural white: DIAN-NW-40 |
| |  Cool white: DIAN-CW-40 |

material: aluminium + stainless steel

weight: 0,1 kg

CE UKCA IP41 12V DC

Dian

golden gloss



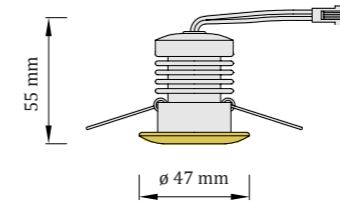



spotlight fixture | interior
operating temperature: - 20 to 60 °C



Light source

6W LED brand CREE (built in)
3000K
4000K
6000K
dimmable (control not included)
power supply not included

Code

- | | |
|------------|---|
| 15° optics |  Warm white: DIAN-WW-15-G |
| |  Natural white: DIAN-NW-15-G |
| |  Cool white: DIAN-CW-15-G |
| 40° optics |  Warm white: DIAN-WW-40-G |
| |  Natural white: DIAN-NW-40-G |
| |  Cool white: DIAN-CW-40-G |

material: aluminium + stainless steel

weight: 0,1 kg

CE UKCA IP41 12V DC

Dian

white matt



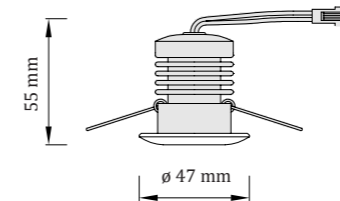



spotlight fixture | interior
operating temperature: - 20 to 60 °C



Light source

6W LED brand CREE (built in)
3000K
4000K
6000K
dimmable (control not included)
power supply not included

Code

- | | |
|------------|---|
| 15° optics |  Warm white: DIAN-WW-15-W |
| |  Natural white: DIAN-NW-15-W |
| |  Cool white: DIAN-CW-15-W |
| 40° optics |  Warm white: DIAN-WW-40-W |
| |  Natural white: DIAN-NW-40-W |
| |  Cool white: DIAN-CW-40-W |

material: aluminium

weight: 0,1 kg

CE UKCA IP41 12V DC



Teardrop Single Mini

suspension lamp

An elegant design element, Teardrop Single lamps boast a wide range of uses.

They are suitable for lighting dining tables, kitchen islands, bar counters, stairways, but also bedside tables or areas near mirrors.





The lamps are supplied with a standard, 2 m suspension cable.
On request, it is possible to make lamps with atypical cable lengths
and develop a proposal for their layout.

TIP: To illuminate the dining table, you can use 12 - 18 lamps
arranged in 2 rows and lowered at different heights.

Types of ceiling grips

suitable for plasterboard

Flat

drill hole: \varnothing 38 - 40 mm

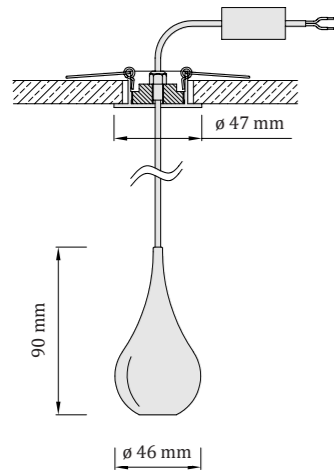

Installation:

It can be installed in the existing plasterboard ceiling - fixing via springs.

Funnel

drill hole: \varnothing 18 mm

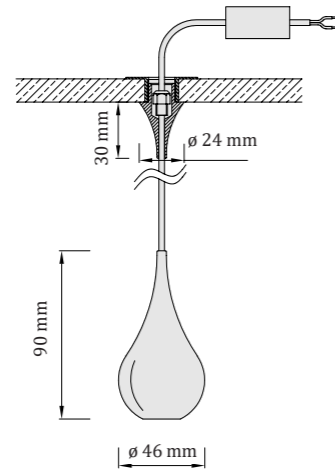

Installation:

Cannot be installed in the existing plasterboard ceiling (plasterboard is not yet installed on the ceiling because you need to glue the counter piece to the ceiling grip from the opposite side of the plasterboard).

Funnel mini

drill hole: \varnothing 7 mm

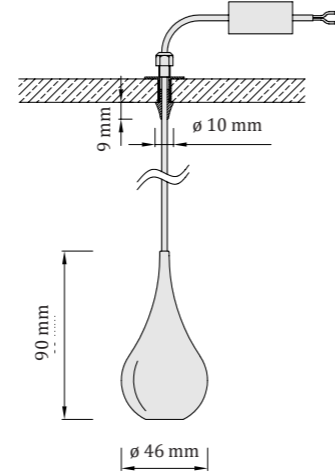

Finish

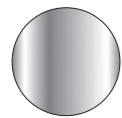

polished stainless steel

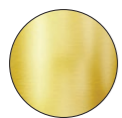

golden gloss



black matt

Beam angle



15°



40°

Teardrop Single Mini

polished stainless steel

suspension lamp | interior
operating temperature: - 20 to 60 °C

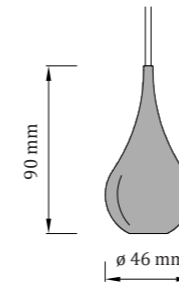

material: stainless steel weight: 0,4 kg

Light source

6W LED, brand CREE
3000K
4000K
6000K
dimmable (control not included)
power supply not included

Code - lamp

15° optics
● Warm white: TDSM-WW-15
● Natural white: TDSM-NW-15
○ Cool white: TDSM-CW-15

40° optics
● Warm white: TDSM-WW-40
● Natural white: TDSM-NW-40
○ Cool white: TDSM-CW-40

Code - ceiling grip

Flat: GRIP-TDSM-A
Funnel: GRIP-TDSM-B
Funnel mini: GRIP-TDSM-C

CE UKCA IP44 12V DC

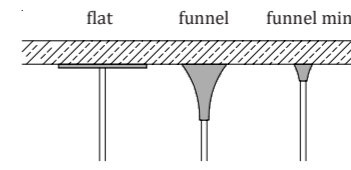

Teardrop Single Mini

golden gloss

suspension lamp | interior
operating temperature: - 20 to 60 °C

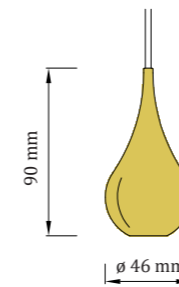

material: stainless steel weight: 0,4 kg

Light source

6W LED, brand CREE
3000K
4000K
6000K
dimmable (control not included)
power supply not included

Code - lamp

15° optics
● Warm white: TDSM-WW-15-G
● Natural white: TDSM-NW-15-G
○ Cool white: TDSM-CW-15-G

40° optics
● Warm white: TDSM-WW-40-G
● Natural white: TDSM-NW-40-G
○ Cool white: TDSM-CW-40-G

Code - ceiling grip

Flat: GRIP-TDSM-A-G
Funnel: GRIP-TDSM-B-G
Funnel mini: GRIP-TDSM-C-G

CE UKCA IP44 12V DC

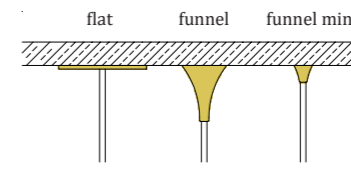

Teardrop Single Mini

black matt

suspension lamp | interior
operating temperature: - 20 to 60 °C

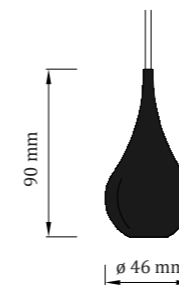

material: aluminium weight: 0,3 kg

Light source

6W LED, brand CREE
3000K
4000K
6000K
dimmable (control not included)
power supply not included

Code - lamp

15° optics
● Warm white: TDSM-WW-15-B
● Natural white: TDSM-NW-15-B
○ Cool white: TDSM-CW-15-B

40° optics
● Warm white: TDSM-WW-40-B
● Natural white: TDSM-NW-40-B
○ Cool white: TDSM-CW-40-B

Code - ceiling grip

Flat: GRIP-TDSM-A-B
Funnel: GRIP-TDSM-B-B
Funnel mini: GRIP-TDSM-C-B

CE UKCA IP44 12V DC

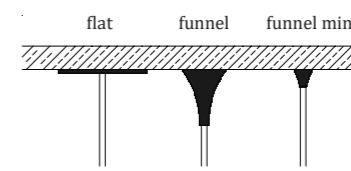



Parachute Single

suspension lamp

Parachute Single collection can be put to many versatile uses. Various groupings can be formed by the lamps to serve as the main lighting for dining tables, kitchen islands, bar counters, stairways, but also bedside tables.

As standard, the lamps are supplied with a 2 m suspension cable.

On request, it is possible to craft lights with atypical cable lengths and develop a proposal for their layout.





Bubbles trapped in glass

A special glassmaking technique is used during glass-blowing to form air bubbles in the glass, which refract and reflect light. The presence of bubbles creates a beautiful shimmering, sparkling effect.

By combining several colour shades, you can create a unique artwork.

Shade

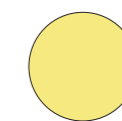

champagne



amber

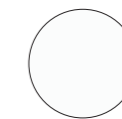

crystal



Types of ceiling grips suitable for plasterboard

Flat

drill hole: \varnothing 38 - 40 mm

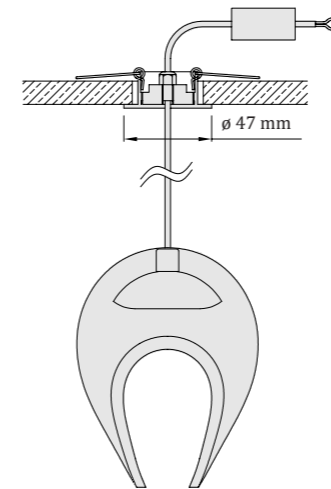

Installation:

It can be installed in the existing plasterboard ceiling - fixing via springs.

Funnel

drill hole: \varnothing 18 mm

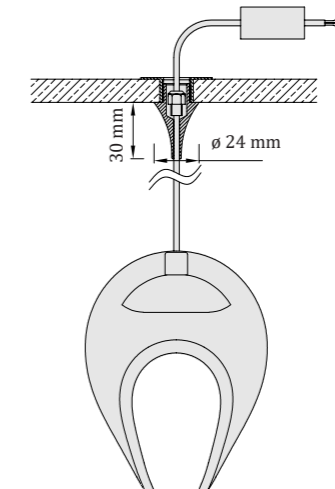

Installation:

Cannot be installed in the existing plasterboard ceiling (plasterboard is not yet installed on the ceiling because you need to glue the counter piece to the ceiling grip from the opposite side of the plasterboard).

Funnel mini

drill hole: \varnothing 7 mm

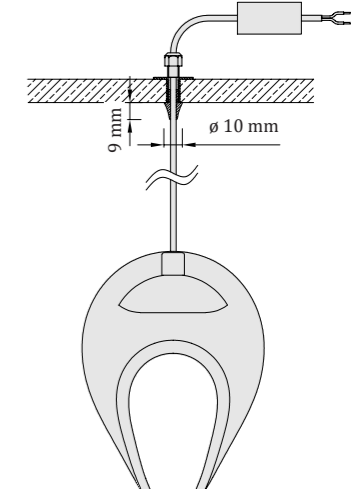

Surface finish

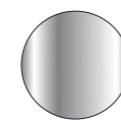

polished stainless steel

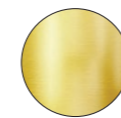

golden gloss

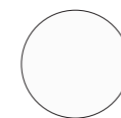

white matt

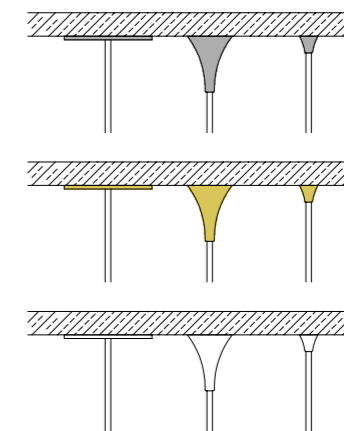

Parachute Single

champagne

suspension lamp | interior
operating temperature: - 20 to 60 °C

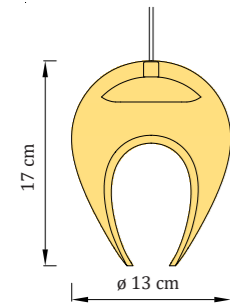

Light source

5W LED, brand CREE
3000K
4000K
6000K
dimmable (control not included)
power supply not included

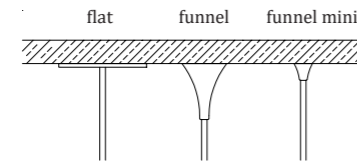

Code - lamp

- Warm white: PAS-WW-CH
- Natural white: PAS-NW-CH
- Cool white: PAS-CW-CH

Code - ceiling grip

Flat:	GRIP-A
Funnel:	GRIP-B
Funnel mini:	GRIP-C
Flat:	GRIP-A-G
Funnel:	GRIP-B-G
Funnel mini:	GRIP-C-G
Flat:	GRIP-A-W
Funnel:	GRIP-B-W
Funnel mini:	GRIP-C-W

white matt
golden gloss
stainless steel

material: glass + stainless steel

weight: 1,5 kg

CE UKCA IP20 24V DC

Parachute Single

amber

suspension lamp | interior
operating temperature: - 20 to 60 °C

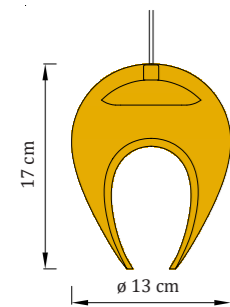

Light source

5W LED, brand CREE
3000K
4000K
6000K
dimmable (control not included)
power supply not included

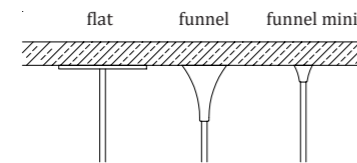

Code - lamp

- Warm white: PAS-WW-AM
- Natural white: PAS-NW-AM
- Cool white: PAS-CW-AM

Code - ceiling grip

Flat:	GRIP-A
Funnel:	GRIP-B
Funnel mini:	GRIP-C
Flat:	GRIP-A-G
Funnel:	GRIP-B-G
Funnel mini:	GRIP-C-G
Flat:	GRIP-A-W
Funnel:	GRIP-B-W
Funnel mini:	GRIP-C-W

white matt
golden gloss
stainless steel

material: glass + stainless steel

weight: 1,5 kg

CE UKCA IP20 24V DC

Parachute Single

crystal

suspension lamp | interior
operating temperature: - 20 to 60 °C

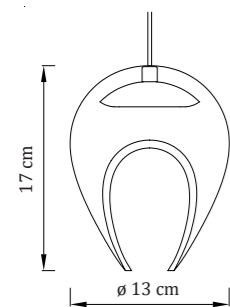

Light source

5W LED, brand CREE
3000K
4000K
6000K
dimmable (control not included)
power supply not included

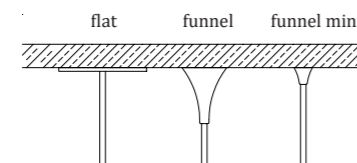

Code - lamp

- Warm white: PAS-WW-CR
- Natural white: PAS-NW-CR
- Cool white: PAS-CW-CR

Code - ceiling grip

Flat:	GRIP-A
Funnel:	GRIP-B
Funnel mini:	GRIP-C
Flat:	GRIP-A-G
Funnel:	GRIP-B-G
Funnel mini:	GRIP-C-G
Flat:	GRIP-A-W
Funnel:	GRIP-B-W
Funnel mini:	GRIP-C-W

white matt
golden gloss
stainless steel

material: glass + stainless steel

weight: 1,5 kg

CE UKCA IP20 24V DC

Parachute Single Mini

champagne

suspension lamp | interior
operating temperature: - 20 to 60 °C

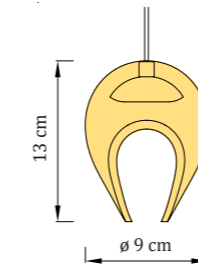

Light source

5W LED, brand CREE
3000K
4000K
6000K
dimmable (control not included)
power supply not included

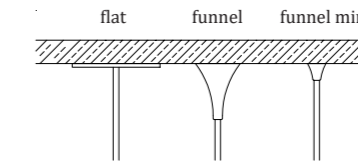

Code - lamp

- Warm white: PASM-WW-CH
- Natural white: PASM-NW-CH
- Cool white: PASM-CW-CH

Code - ceiling grip

Flat:	GRIP-A
Funnel:	GRIP-B
Funnel mini:	GRIP-C
Flat:	GRIP-A-G
Funnel:	GRIP-B-G
Funnel mini:	GRIP-C-G
Flat:	GRIP-A-W
Funnel:	GRIP-B-W
Funnel mini:	GRIP-C-W

white matt
golden gloss
stainless steel

material: glass + stainless steel

weight: 0,8 kg

CE UKCA IP20 24V DC

Parachute Single Mini

amber

suspension lamp | interior
operating temperature: - 20 to 60 °C

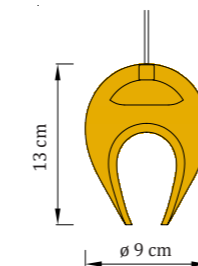

Light source

5W LED, brand CREE
3000K
4000K
6000K
dimmable (control not included)
power supply not included

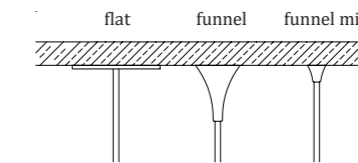

Code - lamp

- Warm white: PASM-WW-AM
- Natural white: PASM-NW-AM
- Cool white: PASM-CW-AM

Code - ceiling grip

Flat:	GRIP-A
Funnel:	GRIP-B
Funnel mini:	GRIP-C
Flat:	GRIP-A-G
Funnel:	GRIP-B-G
Funnel mini:	GRIP-C-G
Flat:	GRIP-A-W
Funnel:	GRIP-B-W
Funnel mini:	GRIP-C-W

white matt
golden gloss
stainless steel

material: glass + stainless steel

weight: 0,8 kg

CE UKCA IP20 24V DC

Parachute Single Mini

crystal

suspension lamp | interior
operating temperature: - 20 to 60 °C

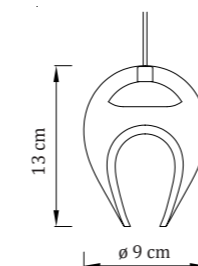

Light source

5W LED, brand CREE
3000K
4000K
6000K
dimmable (control not included)
power supply not included

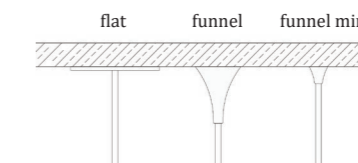

Code - lamp

- Warm white: PASM-WW-CR
- Natural white: PASM-NW-CR
- Cool white: PASM-CW-CR

Code - ceiling grip

Flat:	GRIP-A
Funnel:	GRIP-B
Funnel mini:	GRIP-C
Flat:	GRIP-A-G
Funnel:	GRIP-B-G
Funnel mini:	GRIP-C-G
Flat:	GRIP-A-W
Funnel:	GRIP-B-W
Funnel mini:	GRIP-C-W

white matt
golden gloss
stainless steel

material: glass + stainless steel

weight: 0,8 kg

CE UKCA IP20 24V DC



Aurora

suspension lamp

Aurora epitomizes the attention to detail and design creativity of the glass craft. The beauty of shades lies in their shapes, each one unique, which arise by virtue of the handmade production.

Irregular cuts create the many planes of the hand-ground shade, which is not only a functional lamp but also a work of art.

This elegant design element is ideal for lighting bar counters and kitchen islands.





Aurora mini

suspension lamp

The Aurora collection of lamps is available in 2 sizes, with glass shades in 3 color versions: crystal, champagne and amber.

As standard, the lamps are supplied with a 2 m suspension cable. On request, it is possible to craft lamps with atypical cable lengths and develop a proposal for their layout.

Glass shade

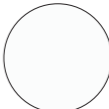
-  champagne
-  amber
-  crystal



Ceiling grip

suitable for plasterboard

Installation:

Cannot be installed in the existing plasterboard ceiling (plasterboard is not yet installed on the ceiling because you need to glue the counter piece to the ceiling grip from the opposite side of the plasterboard).

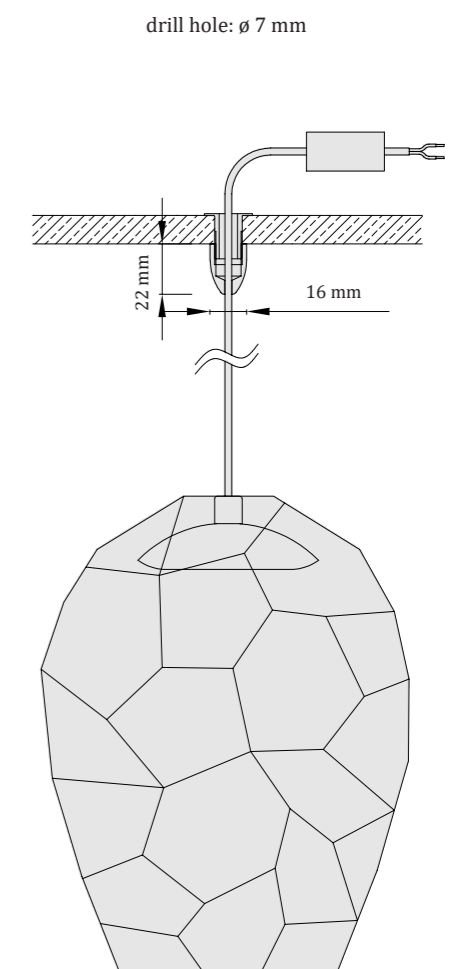

Aurora

champagne

suspension lamp | interior
operating temperature: - 20 to 60 °C

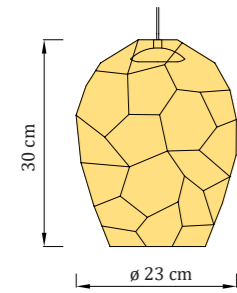

material: glass + stainless steel weight: 3 kg

Light source

5W LED, brand CREE
3000K
4000K
6000K
dimnable (control not included)
power supply not included

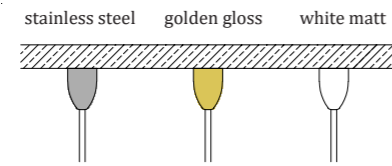

Code - lamp

- Warm white: AU-WW-CH
- Natural white: AU-NW-CH
- Cool white: AU-CW-CH

Code - ceiling grip

Stainless steel: GRIP-D
Golden gloss: GRIP-D-G
White matt: GRIP-D-W

CE UKCA IP20 24V DC

Aurora Mini

champagne

suspension lamp | interior
operating temperature: - 20 to 60 °C

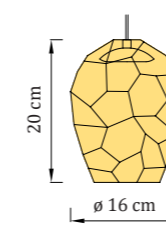

material: glass + stainless steel weight: 2,5 kg

Light source

5W LED, brand CREE
3000K
4000K
6000K
dimnable (control not included)
power supply not included

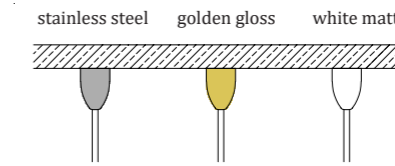

Code - lamp

- Warm white: AUM-WW-CH
- Natural white: AUM-NW-CH
- Cool white: AUM-CW-CH

Code - ceiling grip

Stainless steel: GRIP-D
Golden gloss: GRIP-D-G
White matt: GRIP-D-W

CE UKCA IP20 24V DC

Aurora

amber

suspension lamp | interior
operating temperature: - 20 to 60 °C

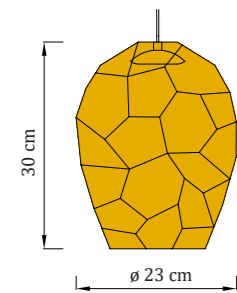

material: glass + stainless steel weight: 3 kg

Light source

5W LED, brand CREE
3000K
4000K
6000K
dimnable (control not included)
power supply not included

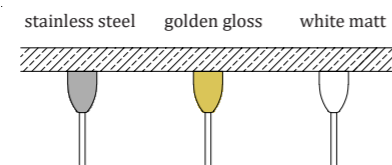

Code - lamp

- Warm white: AU-WW-AM
- Natural white: AU-NW-AM
- Cool white: AU-CW-AM

Code - ceiling grip

Stainless steel: GRIP-D
Golden gloss: GRIP-D-G
White matt: GRIP-D-W

CE UKCA IP20 24V DC

Aurora Mini

amber

suspension lamp | interior
operating temperature: - 20 to 60 °C

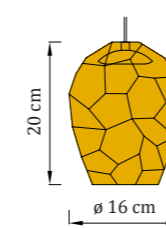

material: glass + stainless steel weight: 2,5 kg

Light source

5W LED, brand CREE
3000K
4000K
6000K
dimnable (control not included)
power supply not included

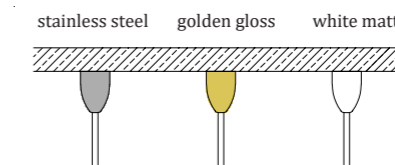

Code - lamp

- Warm white: AUM-WW-AM
- Natural white: AUM-NW-AM
- Cool white: AUM-CW-AM

Code - ceiling grip

Stainless steel: GRIP-D
Golden gloss: GRIP-D-G
White matt: GRIP-D-W

CE UKCA IP20 24V DC

Aurora

crystal

suspension lamp | interior
operating temperature: - 20 to 60 °C

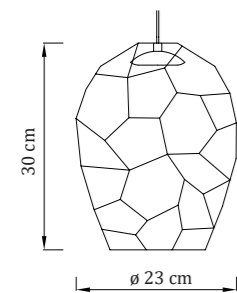

material: glass + stainless steel weight: 3 kg

Light source

5W LED, brand CREE
3000K
4000K
6000K
dimnable (control not included)
power supply not included

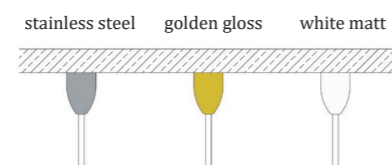

Code - lamp

- Warm white: AU-WW-CR
- Natural white: AU-NW-CR
- Cool white: AU-CW-CR

Code - ceiling grip

Stainless steel: GRIP-D
Golden gloss: GRIP-D-G
White matt: GRIP-D-W

CE UKCA IP20 24V DC

Aurora Mini

crystal

suspension lamp | interior
operating temperature: - 20 to 60 °C

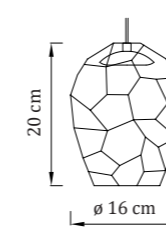

material: glass + stainless steel weight: 2,5 kg

Light source

5W LED, brand CREE
3000K
4000K
6000K
dimnable (control not included)
power supply not included

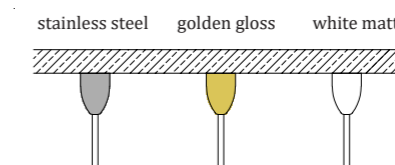

Code - lamp

- Warm white: AUM-WW-CR
- Natural white: AUM-NW-CR
- Cool white: AUM-CW-CR

Code - ceiling grip

Stainless steel: GRIP-D
Golden gloss: GRIP-D-G
White matt: GRIP-D-W

CE UKCA IP20 24V DC

Crystella Wall





Wall lamp with Swarovski crystals

Elegance and luxury best describe the lamps of the Crystella collection. The beauty of the lamps stems from the use of thousands of small Swarovski crystals that reflect and refract light with an impressive sparkling effect.

Crystella Wall shines in both directions and projects spectacular rays on the wall. The small crystals work best with a cool white light source.

Metal base

-  polished stainless steel
-  golden gloss

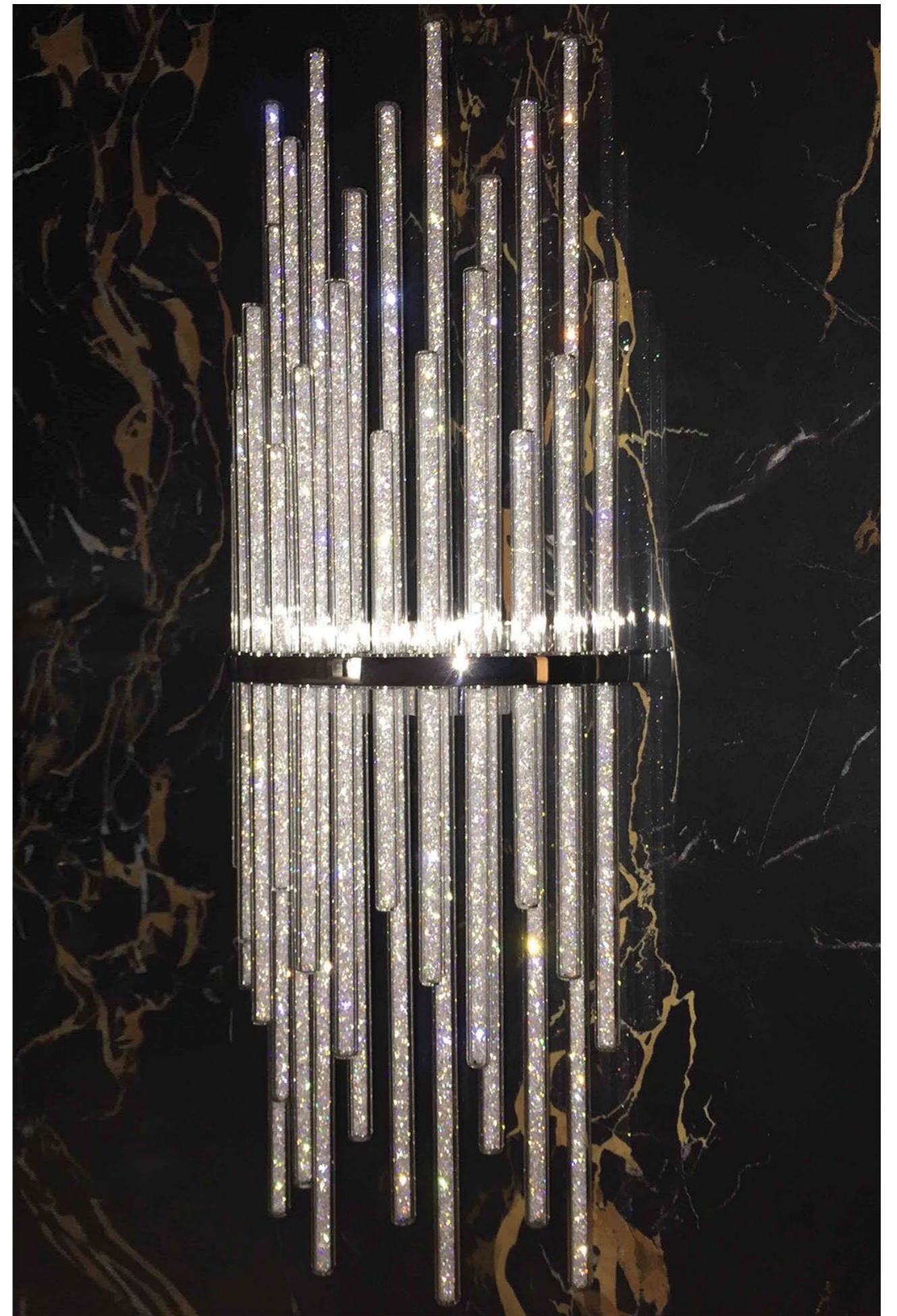

Crystella Wall 50

stainless steel

wall lamp | interior
operating temperature: - 10 to 50 °C

Light source

Input voltage 12V DC:
2 x 5W LED brand CREE
3000K | 4000K | 6000K
dimable (control not included)
power supply not included

Input voltage 230V AC / 50-60 Hz:
2 x 4W LED brand SEOUL
3000K | 4000K | 6000K
non-dimmable

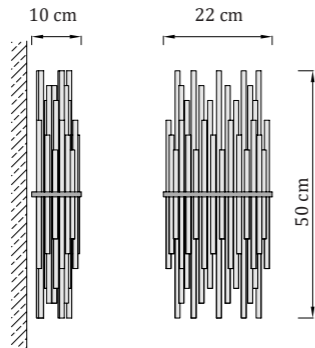

Code	
12V DC	● Warm white: CRW-50-12-WW
	● Natural white: CRW-50-12-NW
	○ Cool white: CRW-50-12-CW

230V AC	● Warm white: CRW-50-230-WW
	● Natural white: CRW-50-230-NW
	○ Cool white: CRW-50-230-CW

material: stainless steel | glass | Swarovski crystals weight: 2,8 kg

CE UKCA IP20 12V DC / 230V AC

Crystella Wall 60

stainless steel

wall lamp | interior
operating temperature: - 10 to 50 °C

Light source

Input voltage 12V DC:
2 x 5W LED brand CREE
3000K | 4000K | 6000K
dimable (control not included)
power supply not included

Input voltage 230V AC / 50-60 Hz:
2 x 4W LED brand SEOUL
3000K | 4000K | 6000K
non-dimmable

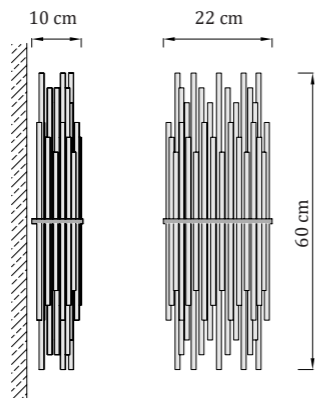

Code	
12V DC	● Warm white: CRW-60-12-WW
	● Natural white: CRW-60-12-NW
	○ Cool white: CRW-60-12-CW

230V AC	● Warm white: CRW-60-230-WW
	● Natural white: CRW-60-230-NW
	○ Cool white: CRW-60-230-CW

material: stainless steel | glass | Swarovski crystals weight: 3,2 kg

CE UKCA IP20 12V DC / 230V AC

Crystella Wall 70

stainless steel

wall lamp | interior
operating temperature: - 10 to 50 °C

Light source

Input voltage 12V DC:
2 x 5W LED brand CREE
3000K | 4000K | 6000K
dimable (control not included)
power supply not included

Input voltage 230V AC / 50-60 Hz:
2 x 4W LED brand SEOUL
3000K | 4000K | 6000K
non-dimmable

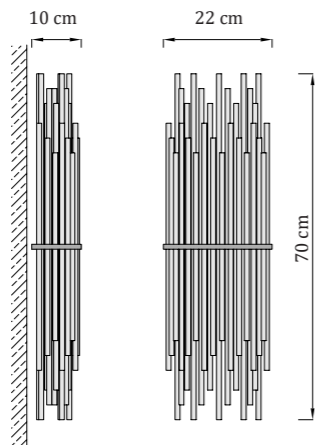

Code	
12V DC	● Warm white: CRW-70-12-WW
	● Natural white: CRW-70-12-NW
	○ Cool white: CRW-70-12-CW

230V AC	● Warm white: CRW-70-230-WW
	● Natural white: CRW-70-230-NW
	○ Cool white: CRW-70-230-CW

material: stainless steel | glass | Swarovski crystals weight: 3,7 kg

CE UKCA IP20 12V DC / 230V AC

Crystella Wall 50

golden gloss

wall lamp | interior
operating temperature: - 10 to 50 °C

Light source

Input voltage 12V DC:
2 x 5W LED brand CREE
3000K | 4000K | 6000K
dimable (control not included)
power supply not included

Input voltage 230V AC / 50-60 Hz:
2 x 4W LED brand SEOUL
3000K | 4000K | 6000K
non-dimmable

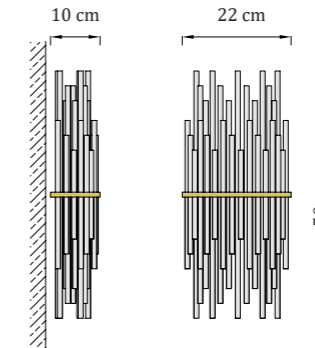

Code	
12V DC	● Warm white: CRW-50-12-WW-G
	● Natural white: CRW-50-12-NW-G
	○ Cool white: CRW-50-12-CW-G

230V AC	● Warm white: CRW-50-230-WW-G
	● Natural white: CRW-50-230-NW-G
	○ Cool white: CRW-50-230-CW-G

material: stainless steel | glass | Swarovski crystals weight: 2,8 kg

CE UKCA IP20 12V DC / 230V AC

Crystella Wall 60

golden gloss

wall lamp | interior
operating temperature: - 10 to 50 °C

Light source

Input voltage 12V DC:
2 x 5W LED brand CREE
3000K | 4000K | 6000K
dimable (control not included)
power supply not included

Input voltage 230V AC / 50-60 Hz:
2 x 4W LED brand SEOUL
3000K | 4000K | 6000K
non-dimmable

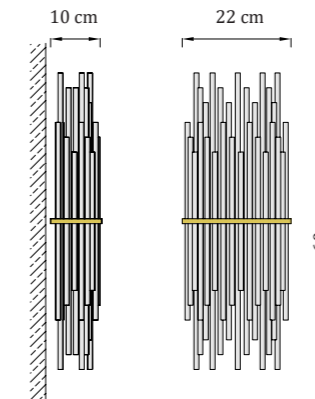

Code	
12V DC	● Warm white: CRW-60-12-WW-G
	● Natural white: CRW-60-12-NW-G
	○ Cool white: CRW-60-12-CW-G

230V AC	● Warm white: CRW-60-230-WW-G
	● Natural white: CRW-60-230-NW-G
	○ Cool white: CRW-60-230-CW-G

material: stainless steel | glass | Swarovski crystals weight: 3,2 kg

CE UKCA IP20 12V DC / 230V AC

Crystella Wall 70

golden gloss

wall lamp | interior
operating temperature: - 10 to 50 °C

Light source

Input voltage 12V DC:
2 x 5W LED brand CREE
3000K | 4000K | 6000K
dimable (control not included)
power supply not included

Input voltage 230V AC / 50-60 Hz:
2 x 4W LED brand SEOUL
3000K | 4000K | 6000K
non-dimmable

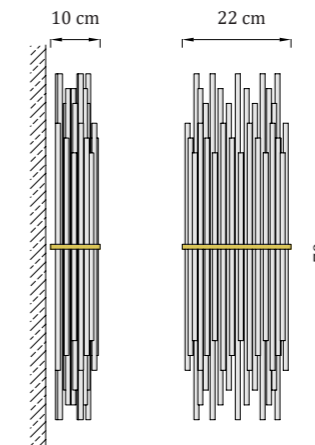

Code	
12V DC	● Warm white: CRW-70-12-WW-G
	● Natural white: CRW-70-12-NW-G
	○ Cool white: CRW-70-12-CW-G

230V AC	● Warm white: CRW-70-230-WW-G
	● Natural white: CRW-70-230-NW-G
	○ Cool white: CRW-70-230-CW-G

material: stainless steel | glass | Swarovski crystals weight: 3,7 kg

CE UKCA IP20 12V DC / 230V AC



Calidos

wall lamp

crafted of hand-blown glass

With its shape and color, Calidos evokes a flame that lights up any space gently and creates a pleasant warm ambiance.

The beauty of the lamps originates from the slight differences between the shapes of the flames and the shade colors, infusing each piece with individuality.





Calidos

wall lamp | interior

operating temperature: - 20 to 60 °C

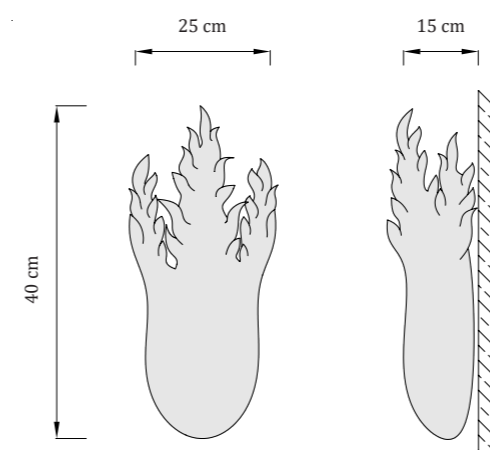

material: stainless steel | glass

weight: 3,6 kg

Light source

LED bulb E14
3000K
6000K
non-dimmable

Code

● Warm white: CAL-AM-WW
○ Cool white: CAL-AM-CW

CE UKCA IP20 230V AC



LIDES s.r.o.
no. 1907, 951 32 Horna Kralova
Slovakia

www.lides.com
lides@lides.sk

LIDES
LIGHT IN DESIGN

LIDES s.r.o. | no. 1907, 951 32 Horna Kralova, Slovakia | lides@lides.sk | www.lides.com