



LIDES  
LIGHT IN DESIGN

Starry sky 2023





Founded in 2012, LIDES aims to furnish the market with elaborately detailed and high-quality lighting that meets demands from the most discerning customers.

The lighting is designed with an emphasis on functionality, to light up the space as needed and enable control compatible with modern technologies available on the market.

A beautiful design element in and of themselves, the lights serve as the main source of illumination while allowing for adjustable brightness to lend the space an atmospheric and relaxed ambiance.

Our assortment combines the beauty of glass and light, art and modern technology, resulting in a unique and unforgettable experience.

In addition to glass, our fixtures incorporate other high-quality materials such as metals with one-of-a-kind surface finishes and uniquely cut Swarovski® crystals.

**We provide post-warranty service and renovation for all our products.**

# LED Crystal

made with crystals from Swarovski®



## Ambiance deluxe

The LED Crystal collection serves for decorative illumination of premium spaces such as spas, saunas, hotel apartments, restaurants and also bathrooms, bedrooms and other relaxation areas.

Uniquely ground crystals diffuse spotlight to create a fancy effect of magnificent shining stars.

## Orientation lighting

Due to their energy efficiency these lamps are also well-suited to provide orientation lighting in hallways and other common areas.

**Light effects are visible only on pale surfaces.**



## Elegance and luxury

The LED Crystal collection is made from authentic crystals from Swarovski®, renowned for their high quality and sparkling appearance. The crystal starry sky will infuse any space with flair and elegance.

There are 10 types of crystals of different cuts, which means that each crystal draws a unique star on the ceiling.

### Lamp body finish

---



polished stainless steel



golden gloss



## Accessories

Each lamp is equipped with a 2 m of cable and a special holder for easy installation in plasterboard ceilings or chipboards.

When ordering a minimum quantity of 6 LED Crystals, the package includes comprehensive accessories:  
plastic mounting holders, conductors with connectors, distribution block, power supply and drill.

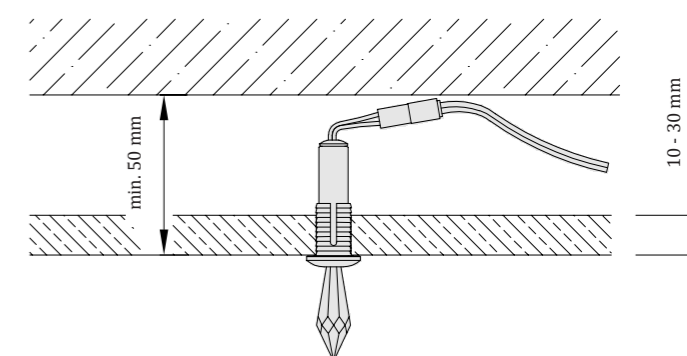

### DROP 18

shining star - diameter approx. 35 cm

**Recommended quantity:**

Small areas: 4 - 5 pcs / 1m<sup>2</sup>

Larger areas: 2 - 3 pcs / 1m<sup>2</sup>

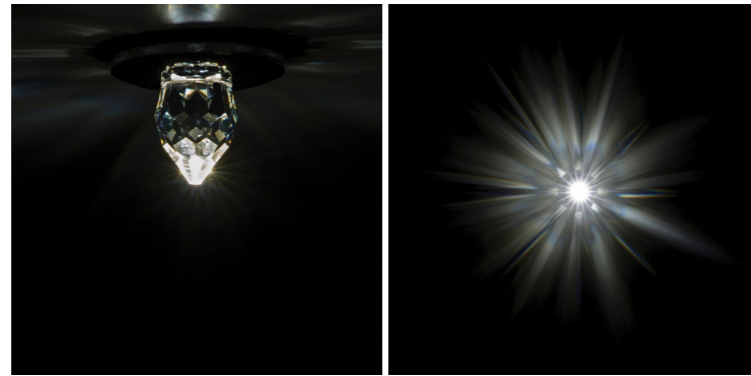

### DROP 40

shining star - diameter approx. 35 cm

**Recommended quantity:**

Small areas: 4 - 5 pcs / 1m<sup>2</sup>

Larger areas: 2 - 3 pcs / 1m<sup>2</sup>

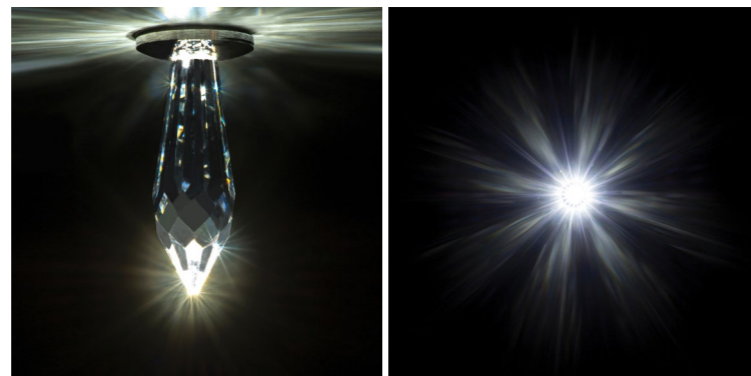

### DROP 50

shining star - diameter approx. 120 cm

**Recommended quantity:** 1 pc / 2m<sup>2</sup>

Best for larger areas

**TIP:** Combine with DROP 18 and DROP 40

In a ratio 45% : 45% : 10%

(DROP 18 : DROP 40 : DROP 50)



### DROP 63

shining star - diameter approx. 45 cm

**Recommended quantity:** 2 - 3 pcs / 1m<sup>2</sup>

**TIP:** Combine with DROP 18 and DROP 40

In a ratio 45% : 45% : 10%

(DROP 18 : DROP 40 : DROP 63)

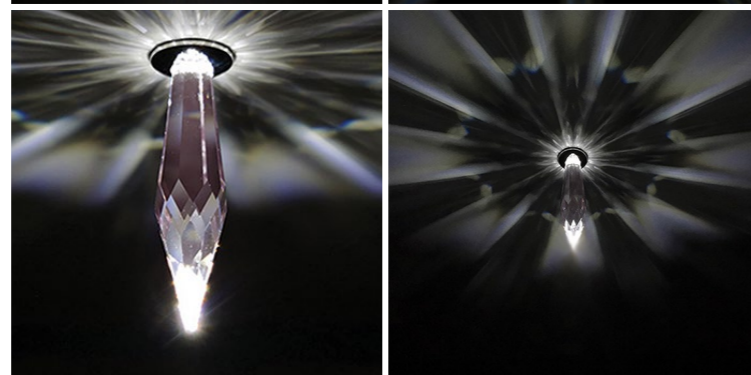

### DROP 100

shining star - diameter approx. 160 cm

**Recommended quantity:** 1 pc / 3m<sup>2</sup>

Best for larger areas

**TIP:** Combine with DROP 18 and DROP 40

In a ratio 45% : 45% : 10%

(DROP 18 : DROP 40 : DROP 100)

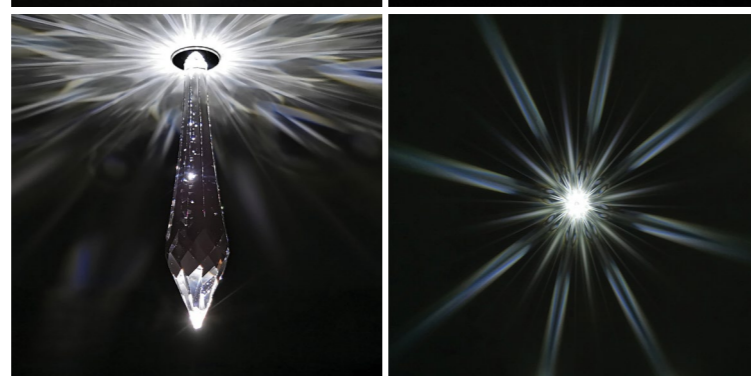

### SPIN DROP

shining star - diameter approx. 40 cm

**Recommended quantity:** 2 - 3 pcs / 1m<sup>2</sup>

**TIP:** Combine with DROP 18 and DROP 40

In a ratio 45% : 45% : 10%

(DROP 18 : DROP 40 : SPIN DROP)

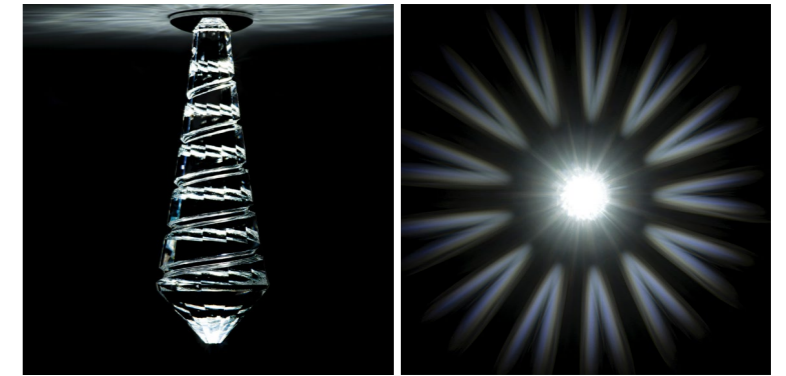

### FLOW 63

shining star - diameter approx. 30 cm

**Recommended quantity:** 3 - 4 pcs / 1m<sup>2</sup>

**TIP:** Combine with FLOW 100

In a ratio 60% : 40% (FLOW 63 : FLOW 100)

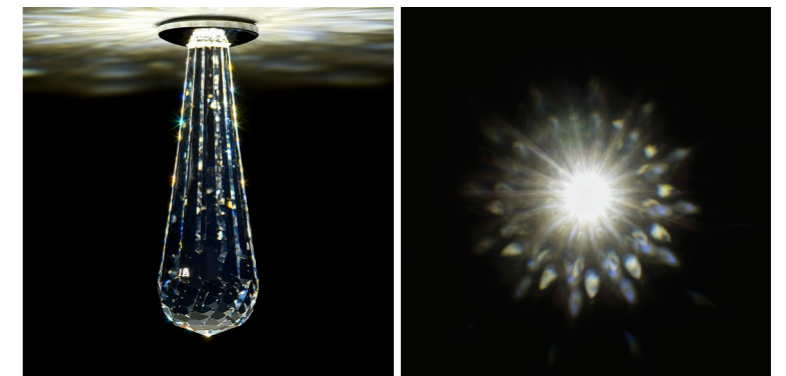

### FLOW 100

shining star - diameter approx. 50 cm

**Recommended quantity:** 2 - 3 pcs / 1m<sup>2</sup>

**TIP:** Combine with FLOW 63

In a ratio 60% : 40% (FLOW 63 : FLOW 100)



### BRIOLETTE 76

shining star - diameter approx. 80 cm

**Recommended quantity:** 1 pc / 2m<sup>2</sup>

Best for larger areas

**TIP:** Combine with BRIOLETTE 100

In a ratio 80% : 20%

(BRIOLETTE 76 : BRIOLETTE 100)

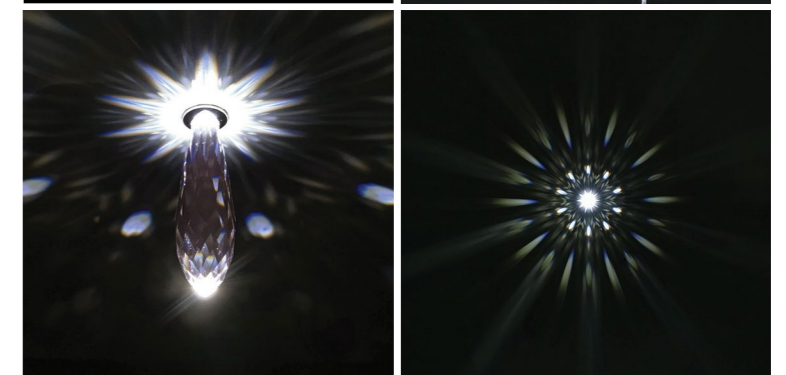

### BRIOLETTE 100

shining star - diameter approx. 180 cm

**Recommended quantity:** 1 pc / 3m<sup>2</sup>

Best for larger areas

**TIP:** Combine with BRIOLETTE 76

In a ratio 80% : 20%

(BRIOLETTE 76 : BRIOLETTE 100)

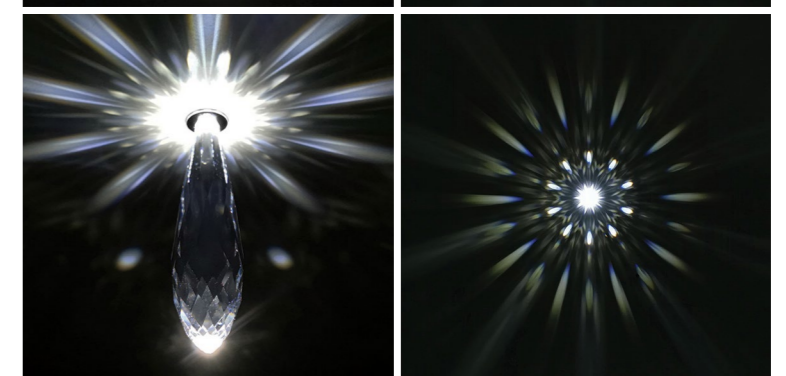

## Drop 18

recessed lamp  
interior | SPA | Wellness | saunas  
operating temperature: - 20 to 120 °C  
material: stainless steel + Swarovski crystal  
finish: polished stainless steel / golden gloss

CE UKCA IP65 5V DC

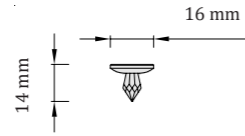

### Light source

0,15W LED  
8500 - 6500K  
non-dimmable

### Code

● stainless steel: DROP18  
● gold: DROP18-G

## Drop 40

recessed lamp  
interior | SPA | Wellness | saunas  
operating temperature: - 20 to 120 °C  
material: stainless steel + Swarovski crystal  
finish: polished stainless steel / golden gloss

CE UKCA IP65 5V DC

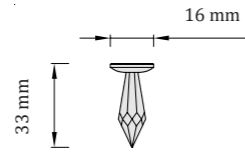

### Light source

0,15W LED  
8500 - 6500K  
non-dimmable

### Code

● stainless steel: DROP40  
● gold: DROP40-G

## Drop 50

recessed lamp  
interior | SPA | Wellness | saunas  
operating temperature: - 20 to 120 °C  
material: stainless steel + Swarovski crystal  
finish: polished stainless steel / golden gloss

CE UKCA IP65 5V DC

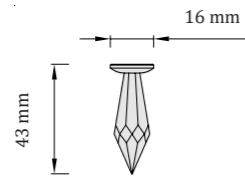

### Light source

0,15W LED  
8500 - 6500K  
non-dimmable

### Code

● stainless steel: DROP50  
● gold: DROP50-G

## Drop 63

recessed lamp  
interior | SPA | Wellness | saunas  
operating temperature: - 20 to 120 °C  
material: stainless steel + Swarovski crystal  
finish: polished stainless steel / golden gloss

CE UKCA IP65 5V DC

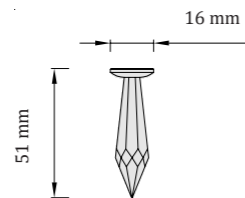

### Light source

0,15W LED  
8500 - 6500K  
non-dimmable

### Code

● stainless steel: DROP63  
● gold: DROP63-G

## Drop 100

recessed lamp  
interior | SPA | Wellness | saunas  
operating temperature: - 20 to 120 °C  
material: stainless steel + Swarovski crystal  
finish: polished stainless steel / golden gloss

CE UKCA IP65 5V DC

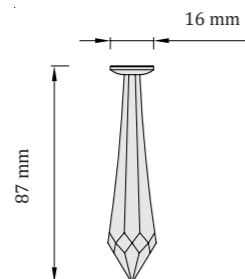

### Light source

0,15W LED  
8500 - 6500K  
non-dimmable

### Code

● stainless steel: DROP100  
● gold: DROP100-G

## Spin Drop

recessed lamp  
interior | SPA | Wellness | saunas  
operating temperature: - 20 to 120 °C  
material: stainless steel + Swarovski crystal  
finish: polished stainless steel / golden gloss

CE UKCA IP65 5V DC

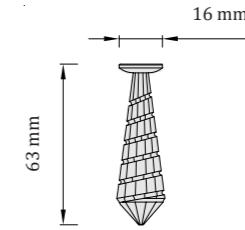

### Light source

0,15W LED  
8500 - 6500K  
non-dimmable

### Code

● stainless steel: SPINDROP  
● gold: SPINDROP-G

## Flow 63

recessed lamp  
interior | SPA | Wellness | saunas  
operating temperature: - 20 to 120 °C  
material: stainless steel + Swarovski crystal  
finish: polished stainless steel / golden gloss

CE UKCA IP65 5V DC

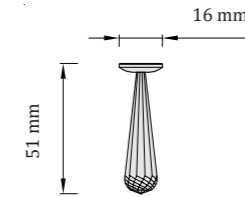

### Light source

0,15W LED  
8500 - 6500K  
non-dimmable

### Code

● stainless steel: FLOW63  
● gold: FLOW63-G

## Flow 100

recessed lamp  
interior | SPA | Wellness | saunas  
operating temperature: - 20 to 120 °C  
material: stainless steel + Swarovski crystal  
finish: polished stainless steel / golden gloss

CE UKCA IP65 5V DC

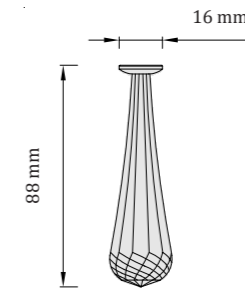

### Light source

0,15W LED  
8500 - 6500K  
non-dimmable

### Code

● stainless steel: FLOW100  
● gold: FLOW100-G

## Briolette 76

recessed lamp  
interior | SPA | Wellness | saunas  
operating temperature: - 20 to 120 °C  
material: stainless steel + Swarovski crystal  
finish: polished stainless steel / golden gloss

CE UKCA IP65 5V DC

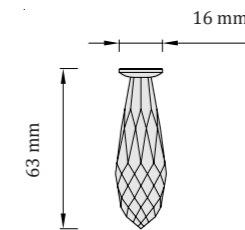

### Light source

0,15W LED  
8500 - 6500K  
non-dimmable

### Code

● stainless steel: BRIOLETTE76  
● gold: BRIOLETTE76-G

## Briolette 100

recessed lamp  
interior | SPA | Wellness | saunas  
operating temperature: - 20 to 120 °C  
material: stainless steel + Swarovski crystal  
finish: polished stainless steel / golden gloss

CE UKCA IP65 5V DC

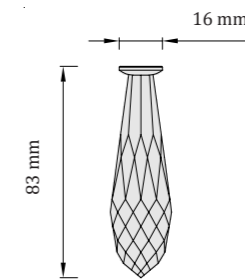

### Light source

0,15W LED  
8500 - 6500K  
non-dimmable

### Code

● stainless steel: BRIOLETTE100  
● gold: BRIOLETTE100-G

# Crystal starry sky



## Complete sets

made with crystals from Swarovski®



*Accessories: plastic holders, conductors, distribution block, power supply and drill*

Sets contain everything necessary for creating your own piece of starry sky. A variety of lamp types from the LED Crystal collection are used in the sets.

The LED Crystal product combines precisely cut crystals with innovative LED technology that boasts long life span and low power consumption.

The pre-assembled sets can be expanded with additional types of lamps from the LED Crystal collection and thus create unique lighting effects.



## Crystal starry sky - complete sets

### DROP 18 | DROP 40

interior | SPA | Wellness | saunas  
 operating temperature: - 20 to 120 °C  
 material: stainless steel + Swarovski crystal  
 finish: polished stainless steel / golden gloss

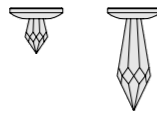

#### Light source

0,15W LED  
 8500 - 6500K  
 non-dimmable

CE UKCA IP65 Complete set: 230V AC / 50-60 Hz  
 Individual LED Crystal: 5V DC

	Qty of lamps in the set	Code
Stainless steel	6 (3+3)	SW01-A
	12 (6+6)	SW02-A
	25 (13+12)	SW03-A
	50 (25+25)	SW04-A
	75 (38+37)	SW05-A
	100 (50+50)	SW06-A
120 (60+60)	SW07-A	

	Qty of lamps in the set	Code
Gold	6 (3+3)	SW01-A-G
	12 (6+6)	SW02-A-G
	25 (13+12)	SW03-A-G
	50 (25+25)	SW04-A-G
	75 (38+37)	SW05-A-G
	100 (50+50)	SW06-A-G
120 (60+60)	SW07-A-G	

## Crystal starry sky - complete sets

### DROP 18 | DROP 40 | DROP 50

interior | SPA | Wellness | saunas  
 operating temperature: - 20 to 120 °C  
 material: stainless steel + Swarovski crystal  
 finish: polished stainless steel / golden gloss

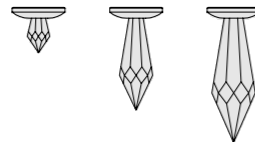

#### Light source

0,15W LED  
 8500 - 6500K  
 non-dimmable

CE UKCA IP65 Complete set: 230V AC / 50-60 Hz  
 Individual LED Crystal: 5V DC

	Qty of lamps in the set	Code
Stainless steel	6 (2+2+2)	SW01-B
	12 (5+5+2)	SW02-B
	25 (10+10+5)	SW03-B
	50 (20+20+10)	SW04-B
	75 (30+30+15)	SW05-B
	100 (40+40+20)	SW06-B
120 (50+50+20)	SW07-B	

	Qty of lamps in the set	Code
Gold	6 (2+2+2)	SW01-B-G
	12 (5+5+2)	SW02-B-G
	25 (10+10+5)	SW03-B-G
	50 (20+20+10)	SW04-B-G
	75 (30+30+15)	SW05-B-G
	100 (40+40+20)	SW06-B-G
120 (50+50+20)	SW07-B-G	

## Crystal starry sky - complete sets

### DROP 18 | DROP 40 | DROP 63

interior | SPA | Wellness | saunas  
 operating temperature: - 20 to 120 °C  
 material: stainless steel + Swarovski crystal  
 finish: polished stainless steel / golden gloss

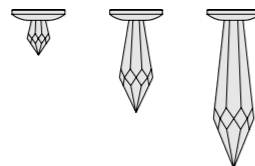

#### Light source

0,15W LED  
 8500 - 6500K  
 non-dimmable

CE UKCA IP65 Complete set: 230V AC / 50-60 Hz  
 Individual LED Crystal: 5V DC

	Qty of lamps in the set	Code
Stainless steel	6 (2+2+2)	SW01-C
	12 (5+5+2)	SW02-C
	25 (10+10+5)	SW03-C
	50 (20+20+10)	SW04-C
	75 (30+30+15)	SW05-C
	100 (40+40+20)	SW06-C
120 (50+50+20)	SW07-C	

	Qty of lamps in the set	Code
Gold	6 (2+2+2)	SW01-C-G
	12 (5+5+2)	SW02-C-G
	25 (10+10+5)	SW03-C-G
	50 (20+20+10)	SW04-C-G
	75 (30+30+15)	SW05-C-G
	100 (40+40+20)	SW06-C-G
120 (50+50+20)	SW07-C-G	

Sets contain the following accessories: plastic mounting holders, conductors with connectors, distribution block, power supply and drill.

## Crystal starry sky - complete sets

### DROP 18 | DROP 40 | SPIN DROP

interior | SPA | Wellness | saunas  
 operating temperature: - 20 to 120 °C  
 material: stainless steel + Swarovski crystal  
 finish: polished stainless steel / golden gloss

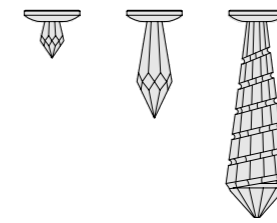

#### Light source

0,15W LED  
 8500 - 6500K  
 non-dimmable

CE UKCA IP65 Complete set: 230V AC / 50-60 Hz  
 Individual LED Crystal: 5V DC

	Qty of lamps in the set	Code
Stainless steel	6 (2+2+2)	SW01-D
	12 (5+5+2)	SW02-D
	25 (10+10+5)	SW03-D
	50 (20+20+10)	SW04-D
	75 (30+30+15)	SW05-D
	100 (40+40+20)	SW06-D
120 (50+50+20)	SW07-D	

	Qty of lamps in the set	Code
Gold	6 (2+2+2)	SW01-D-G
	12 (5+5+2)	SW02-D-G
	25 (10+10+5)	SW03-D-G
	50 (20+20+10)	SW04-D-G
	75 (30+30+15)	SW05-D-G
	100 (40+40+20)	SW06-D-G
120 (50+50+20)	SW07-D-G	

## Crystal starry sky - complete sets

### FLOW 63 | FLOW 100

interior | SPA | Wellness | saunas  
 operating temperature: - 20 to 120 °C  
 material: stainless steel + Swarovski crystal  
 finish: polished stainless steel / golden gloss

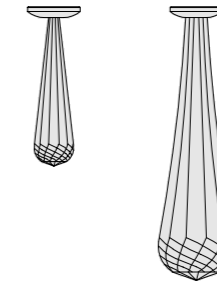

#### Light source

0,15W LED  
 8500 - 6500K  
 non-dimmable

CE UKCA IP65 Complete set: 230V AC / 50-60 Hz  
 Individual LED Crystal: 5V DC

	Qty of lamps in the set	Code
Stainless steel	6 (4+2)	SW01-E
	12 (9+3)	SW02-E
	25 (20+5)	SW03-E
	50 (40+10)	SW04-E

	Qty of lamps in the set	Code
Gold	6 (4+2)	SW01-E-G
	12 (9+3)	SW02-E-G
	25 (20+5)	SW03-E-G
	50 (40+10)	SW04-E-G

## Crystal starry sky - complete sets

### BRIOLETTE 76 | BRIOLETTE 100

interior | SPA | Wellness | saunas  
 operating temperature: - 20 to 120 °C  
 material: stainless steel + Swarovski crystal  
 finish: polished stainless steel / golden gloss

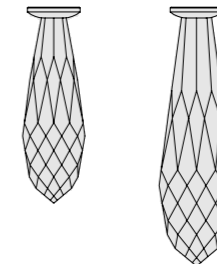

#### Light source

0,15W LED  
 8500 - 6500K  
 non-dimmable

CE UKCA IP65 Complete set: 230V AC / 50-60 Hz  
 Individual LED Crystal: 5V DC

	Qty of lamps in the set	Code
Stainless steel	6 (4+2)	SW01-F
	12 (10+2)	SW02-F
	25 (21+4)	SW03-F

	Qty of lamps in the set	Code
Gold	6 (4+2)	SW01-F-G
	12 (10+2)	SW02-F-G
	25 (21+4)	SW03-F-G

Sets contain the following accessories: plastic mounting holders, conductors with connectors, distribution block, power supply and drill.

# Optical starry sky



## Like stars across the sky

The lighting system based on optical fibers most realistically imitates the night sky with stars.

Optical fibers applied in the ceiling are led to a central light source.

Light from the source is transmitted along the fibers and exits at the other end. Each thread thus represents one shining star.

## Adjustable intensity

Thanks to modern technology, it is possible to set the intensity of the lights as you please and make the stars look more realistic. This type of lighting is perfect for spas, hotels, restaurants, home cinemas, bedrooms, bathrooms, swimming pools and other interior spaces to create a dreamy effect.

Optical fibers are suitable for installation in plasterboard ceilings or chipboards.



## Complete sets

The offer includes various sets made for specific surfaces in different densities.

The sets contain all accessories needed to assemble the starry sky.

There are several versions of the LED projector to choose from. The most realistic version of the star display is offered by the LED projector in cool white (CW).

The use of a multi-color projector (RGB / RGBW) allows you to create colorful static or changing effects.

**TIP:** A combination of both LED projectors is also possible, in which case it is recommended to connect 70% of the fiber cables to the CW projector and 30% of the fiber cables to the RGB (RGBW) projector.

## Accessories

Optical fibers of 3 diameters:

0,75 mm, 1 mm and 1,5 mm in a ratio of 90% : 5% : 5% ,

LED projector, power supply, glue, drills,

RGB (RGBW) controller included for a multicolor version,

paper template (optional).

## Paper template

To facilitate installation, we offer a printed paper template with a design of the star layout.

**If needed we can tailor a set to your needs.**



## Complete set - 150 optical fibers

area 2 x 1 m

interior | SPA | Wellness | saunas  
operating temperature: - 20 to 120 °C

Accessories

optical fibers, LED projector OP2, power supply, glue, drills,  
RGB (RGBW) controller in case of multicolor version, paper template (optional)

Optical fibers

2m length - ø 0,75 mm - 60 pcs  
2m length - ø 1,00 mm - 10 pcs  
2m length - ø 1,50 mm - 5 pcs

3m length - ø 0,75 mm - 60 pcs  
3m length - ø 1,00 mm - 10 pcs  
3m length - ø 1,50 mm - 5 pcs

Light source - LED module CREE

● Warm white: 5W LED | 3000 K  
● Natural white: 5W LED | 4000 K  
○ Cool white: 5W LED | 6000 K  
● RGB: 5W LED  
● RGBW: 6W LED

Code

● Warm white: OS2-150-2x1-WW  
● Natural white: OS2-150-2x1-NW  
○ Cool white: OS2-150-2x1-CW  
● RGB: OS2-150-2x1-RGB  
● RGBW: OS2-150-2x1-RGBW

CE UKCA IP65 Complete set: 230V AC / 50-60 Hz LED projektor: 12V DC

## Complete set - 230 optical fibers

area 2 x 1 m

interior | SPA | Wellness | saunas  
operating temperature: - 20 to 120 °C

Accessories

optical fibers, LED projector OP2, power supply, glue, drills,  
RGB (RGBW) controller in case of multicolor version, paper template (optional)

Optical fibers

2m length - ø 0,75 mm - 100 pcs  
2m length - ø 1,00 mm - 10 pcs  
2m length - ø 1,50 mm - 5 pcs

3m length - ø 0,75 mm - 100 pcs  
3m length - ø 1,00 mm - 10 pcs  
3m length - ø 1,50 mm - 5 pcs

Light source - LED module CREE

● Warm white: 5W LED | 3000 K  
● Natural white: 5W LED | 4000 K  
○ Cool white: 5W LED | 6000 K  
● RGB: 5W LED  
● RGBW: 6W LED

Code

● Warm white: OS2-230-2x1-WW  
● Natural white: OS2-230-2x1-NW  
○ Cool white: OS2-230-2x1-CW  
● RGB: OS2-230-2x1-RGB  
● RGBW: OS2-230-2x1-RGBW

CE UKCA IP65 Complete set: 230V AC / 50-60 Hz LED projektor: 12V DC

## Complete set - 430 optical fibers

area 2 x 1 m

interior | SPA | Wellness | saunas  
operating temperature: - 20 to 120 °C

Accessories

optical fibers, LED projector OP2, power supply, glue, drills,  
RGB (RGBW) controller in case of multicolor version, paper template (optional)

Optical fibers

2m length - ø 0,75 mm - 190 pcs  
2m length - ø 1,00 mm - 15 pcs  
2m length - ø 1,50 mm - 10 pcs

3m length - ø 0,75 mm - 190 pcs  
3m length - ø 1,00 mm - 15 pcs  
3m length - ø 1,50 mm - 10 pcs

Light source - LED module CREE

● Warm white: 5W LED | 3000 K  
● Natural white: 5W LED | 4000 K  
○ Cool white: 5W LED | 6000 K  
● RGB: 5W LED  
● RGBW: 6W LED

Code

● Warm white: OS2-430-2x1-WW  
● Natural white: OS2-430-2x1-NW  
○ Cool white: OS2-430-2x1-CW  
● RGB: OS2-430-2x1-RGB  
● RGBW: OS2-430-2x1-RGBW

CE UKCA IP65 Complete set: 230V AC / 50-60 Hz LED projektor: 12V DC

*Note: The sets can be dimmed using external controllers. They work on the principle of low-voltage dimming.*

## Complete set - 330 optical fibers

### area 2 x 1,5 m

interior | SPA | Wellness | saunas  
operating temperature: - 20 to 120 °C

#### Accessories

optical fibers, LED projector OP2, power supply, glue, drills,  
RGB (RGBW) controller in case of multicolor version, paper template (optional)

#### Optical fibers

2,5m length - ø 0,75 mm - 150 pcs  
2,5m length - ø 1,00 mm - 10 pcs  
2,5m length - ø 1,50 mm - 5 pcs

3,5m length - ø 0,75 mm - 150 pcs  
3,5m length - ø 1,00 mm - 10 pcs  
3,5m length - ø 1,50 mm - 5 pcs

#### Light source - LED module CREE

● Warm white: 5W LED | 3000 K  
● Natural white: 5W LED | 4000 K  
○ Cool white: 5W LED | 6000 K  
● RGB: 5W LED  
● RGBW: 6W LED

#### Code

● Warm white: OS2-330-2x1,5-WW  
● Natural white: OS2-330-2x1,5-NW  
○ Cool white: OS2-330-2x1,5-CW  
● RGB: OS2-330-2x1,5-RGB  
● RGBW: OS2-330-2x1,5-RGBW

CE UKCA IP65 Complete set: 230V AC / 50-60 Hz LED projector: 12V DC

## Complete set - 530 optical fibers

### area 2 x 1,5 m

interior | SPA | Wellness | saunas  
operating temperature: - 20 to 120 °C

#### Accessories

optical fibers, LED projector OP2, power supply, glue, drills,  
RGB (RGBW) controller in case of multicolor version, paper template (optional)

#### Optical fibers

2,5m length - ø 0,75 mm - 240 pcs  
2,5m length - ø 1,00 mm - 15 pcs  
2,5m length - ø 1,50 mm - 10 pcs

3,5m length - ø 0,75 mm - 240 pcs  
3,5m length - ø 1,00 mm - 15 pcs  
3,5m length - ø 1,50 mm - 10 pcs

#### Light source - LED module CREE

● Warm white: 5W LED | 3000 K  
● Natural white: 5W LED | 4000 K  
○ Cool white: 5W LED | 6000 K  
● RGB: 5W LED  
● RGBW: 6W LED

#### Code

● Warm white: OS2-530-2x1,5-WW  
● Natural white: OS2-530-2x1,5-NW  
○ Cool white: OS2-530-2x1,5-CW  
● RGB: OS2-530-2x1,5-RGB  
● RGBW: OS2-530-2x1,5-RGBW

CE UKCA IP65 Complete set: 230V AC / 50-60 Hz LED projector: 12V DC

## Complete set - 400 optical fibers

### area 3 x 1,5 m

interior | SPA | Wellness | saunas  
operating temperature: - 20 to 120 °C

#### Accessories

optical fibers, LED projector OP2, power supply, glue, drills,  
RGB (RGBW) controller in case of multicolor version, paper template (optional)

#### Optical fibers

3m length - ø 0,75 mm - 180 pcs  
3m length - ø 1,00 mm - 10 pcs  
3m length - ø 1,50 mm - 10 pcs

4m length - ø 0,75 mm - 180 pcs  
4m length - ø 1,00 mm - 10 pcs  
4m length - ø 1,50 mm - 10 pcs

#### Light source - LED module CREE

● Warm white: 5W LED | 3000 K  
● Natural white: 5W LED | 4000 K  
○ Cool white: 5W LED | 6000 K  
● RGB: 5W LED  
● RGBW: 6W LED

#### Code

● Warm white: OS2-400-3x1,5-WW  
● Natural white: OS2-400-3x1,5-NW  
○ Cool white: OS2-400-3x1,5-CW  
● RGB: OS2-400-3x1,5-RGB  
● RGBW: OS2-400-3x1,5-RGBW

CE UKCA IP65 Complete set: 230V AC / 50-60 Hz LED projector: 12V DC

*Note: The sets can be dimmed using external controllers. They work on the principle of low-voltage dimming.*

## Complete set - 600 optical fibers

### area 3 x 1,5 m

interior | SPA | Wellness | saunas  
operating temperature: - 20 to 120 °C

#### Accessories

optical fibers, LED projector OP1, power supply, glue, drills,  
RGB (RGBW) controller in case of multicolor version, paper template (optional)

#### Optical fibers

3m length - ø 0,75 mm - 270 pcs  
3m length - ø 1,00 mm - 15 pcs  
3m length - ø 1,50 mm - 15 pcs

4m length - ø 0,75 mm - 270 pcs  
4m length - ø 1,00 mm - 15 pcs  
4m length - ø 1,50 mm - 15 pcs

#### Light source - LED module CREE

● Warm white: 16W LED | 3000 K  
● Natural white: 16W LED | 4000 K  
○ Cool white: 16W LED | 6000 K  
● RGB: 11W LED  
● RGBW: 16W LED

#### Code

● Warm white: OS1-600-3x1,5-WW  
● Natural white: OS1-600-3x1,5-NW  
○ Cool white: OS1-600-3x1,5-CW  
● RGB: OS1-600-3x1,5-RGB  
● RGBW: OS1-600-3x1,5-RGBW

CE UKCA IP65 Complete set: 230V AC / 50-60 Hz LED projector: 24V DC

## Complete set - 550 optical fibers

### area 3 x 2 m

interior | SPA | Wellness | saunas  
operating temperature: - 20 to 120 °C

#### Accessories

optical fibers, LED projector OP2, power supply, glue, drills,  
RGB (RGBW) controller in case of multicolor version, paper template (optional)

#### Optical fibers

3m length - ø 0,75 mm - 255 pcs  
3m length - ø 1,00 mm - 10 pcs  
3m length - ø 1,50 mm - 10 pcs

5m length - ø 0,75 mm - 255 pcs  
5m length - ø 1,00 mm - 10 pcs  
5m length - ø 1,50 mm - 10 pcs

#### Light source - LED module CREE

● Warm white: 5W LED | 3000 K  
● Natural white: 5W LED | 4000 K  
○ Cool white: 5W LED | 6000 K  
● RGB: 5W LED  
● RGBW: 6W LED

#### Code

● Warm white: OS2-550-3x2-WW  
● Natural white: OS2-550-3x2-NW  
○ Cool white: OS2-550-3x2-CW  
● RGB: OS2-550-3x2-RGB  
● RGBW: OS2-550-3x2-RGBW

CE UKCA IP65 Complete set: 230V AC / 50-60 Hz LED projector: 12V DC

## Complete set - 750 optical fibers

### area 3 x 2 m

interior | SPA | Wellness | saunas  
operating temperature: - 20 to 120 °C

#### Accessories

optical fibers, LED projector OP1, power supply, glue, drills,  
RGB (RGBW) controller in case of multicolor version, paper template (optional)

#### Optical fibers

3m length - ø 0,75 mm - 345 pcs  
3m length - ø 1,00 mm - 15 pcs  
3m length - ø 1,50 mm - 15 pcs

5m length - ø 0,75 mm - 345 pcs  
5m length - ø 1,00 mm - 15 pcs  
5m length - ø 1,50 mm - 15 pcs

#### Light source - LED module CREE

● Warm white: 16W LED | 3000 K  
● Natural white: 16W LED | 4000 K  
○ Cool white: 16W LED | 6000 K  
● RGB: 11W LED  
● RGBW: 16W LED

#### Code

● Warm white: OS1-750-3x2-WW  
● Natural white: OS1-750-3x2-NW  
○ Cool white: OS1-750-3x2-CW  
● RGB: OS1-750-3x2-RGB  
● RGBW: OS1-750-3x2-RGBW

CE UKCA IP65 Complete set: 230V AC / 50-60 Hz LED projector: 24V DC

*Note: The sets can be dimmed using external controllers. They work on the principle of low-voltage dimming.*

## Complete set - 700 optical fibers

### area 3 x 3 m

interior | SPA | Wellness | saunas  
operating temperature: - 20 to 120 °C

#### Accessories

optical fibers, LED projector OP1, power supply, glue, drills,  
RGB (RGBW) controller in case of multicolor version, paper template (optional)

#### Optical fibers

4m length - ø 0,75 mm - 320 pcs  
4m length - ø 1,00 mm - 15 pcs  
4m length - ø 1,50 mm - 15 pcs

6m length - ø 0,75 mm - 320 pcs  
6m length - ø 1,00 mm - 15 pcs  
6m length - ø 1,50 mm - 15 pcs

#### Light source - LED module CREE

● Warm white: 16W LED | 3000 K  
● Natural white: 16W LED | 4000 K  
○ Cool white: 16W LED | 6000 K  
● RGB: 11W LED  
● RGBW: 16W LED

#### Code

● Warm white: OS1-700-3x3-WW  
● Natural white: OS1-700-3x3-NW  
○ Cool white: OS1-700-3x3-CW  
● RGB: OS1-700-3x3-RGB  
● RGBW: OS1-700-3x3-RGBW



Complete set: 230V AC / 50-60 Hz

LED projector: 24V DC

## Complete set - 850 optical fibers

### area 3 x 3 m

interior | SPA | Wellness | saunas  
operating temperature: - 20 to 120 °C

#### Accessories

optical fibers, LED projector OP1, power supply, glue, drills,  
RGB (RGBW) controller in case of multicolor version, paper template (optional)

#### Optical fibers

4m length - ø 0,75 mm - 385 pcs  
4m length - ø 1,00 mm - 20 pcs  
4m length - ø 1,50 mm - 20 pcs

6m length - ø 0,75 mm - 385 pcs  
6m length - ø 1,00 mm - 20 pcs  
6m length - ø 1,50 mm - 20 pcs

#### Light source - LED module CREE

● Warm white: 16W LED | 3000 K  
● Natural white: 16W LED | 4000 K  
○ Cool white: 16W LED | 6000 K  
● RGB: 11W LED  
● RGBW: 16W LED

#### Code

● Warm white: OS1-850-3x3-WW  
● Natural white: OS1-850-3x3-NW  
○ Cool white: OS1-850-3x3-CW  
● RGB: OS1-850-3x3-RGB  
● RGBW: OS1-850-3x3-RGBW



Complete set: 230V AC / 50-60 Hz

LED projector: 24V DC

## Complete set - 800 optical fibers

### area 4 x 3 m

interior | SPA | Wellness | saunas  
operating temperature: - 20 to 120 °C

#### Accessories

optical fibers, LED projector OP1, power supply, glue, drills,  
RGB (RGBW) controller in case of multicolor version, paper template (optional)

#### Optical fibers

3m length - ø 0,75 mm - 160 pcs  
3m length - ø 1,00 mm - 10 pcs  
3m length - ø 1,50 mm - 10 pcs

4,5m length - ø 0,75 mm - 400 pcs  
4,5m length - ø 1,00 mm - 20 pcs  
4,5m length - ø 1,50 mm - 20 pcs

6m length - ø 0,75 mm - 160 pcs  
6m length - ø 1,00 mm - 10 pcs  
6m length - ø 1,50 mm - 10 pcs

#### Light source - LED module CREE

● Warm white: 16W LED | 3000 K  
● Natural white: 16W LED | 4000 K  
○ Cool white: 16W LED | 6000 K  
● RGB: 11W LED  
● RGBW: 16W LED

#### Code

● Warm white: OS1-800-4x3-WW  
● Natural white: OS1-800-4x3-NW  
○ Cool white: OS1-800-4x3-CW  
● RGB: OS1-800-4x3-RGB  
● RGBW: OS1-800-4x3-RGBW



Complete set: 230V AC / 50-60 Hz

LED projector: 24V DC

*Note: The sets can be dimmed using external controllers. They work on the principle of low-voltage dimming.*

## Complete set - 1100 optical fibers

### area 4 x 3 m

interior | SPA | Wellness | saunas  
operating temperature: - 20 to 120 °C

#### Accessories

optical fibers, LED projector OP2 - 2 pcs., power supply, glue, drills,  
RGB (RGBW) controller in case of multicolor version, paper template (optional)

#### Optical fibers

3m length - ø 0,75 mm - 230 pcs  
3m length - ø 1,00 mm - 10 pcs  
3m length - ø 1,50 mm - 10 pcs

4,5m length - ø 0,75 mm - 560 pcs  
4,5m length - ø 1,00 mm - 20 pcs  
4,5m length - ø 1,50 mm - 20 pcs

6m length - ø 0,75 mm - 230 pcs  
6m length - ø 1,00 mm - 10 pcs  
6m length - ø 1,50 mm - 10 pcs

#### Light source - LED module CREE

● Warm white: 2 x 5W LED | 3000 K  
● Natural white: 2 x 5W LED | 4000 K  
○ Cool white: 2 x 5W LED | 6000 K  
● RGB: 2 x 5W LED  
● RGBW: 2 x 6W LED

#### Code

● Warm white: OS2-1100-4x3-WW  
● Natural white: OS2-1100-4x3-NW  
○ Cool white: OS2-1100-4x3-CW  
● RGB: OS2-1100-4x3-RGB  
● RGBW: OS2-1100-4x3-RGBW



Complete set: 230V AC / 50-60 Hz

LED projector: 12V DC

## Complete set - 900 optical fibers

### area 5 x 3 m

interior | SPA | Wellness | saunas  
operating temperature: - 20 to 120 °C

#### Accessories

optical fibers, LED projector OP1, power supply, glue, drills,  
RGB (RGBW) controller in case of multicolor version, paper template (optional)

#### Optical fibers

3m length - ø 0,75 mm - 150 pcs  
3m length - ø 1,00 mm - 5 pcs  
3m length - ø 1,50 mm - 5 pcs

5m length - ø 0,75 mm - 300 pcs  
5m length - ø 1,00 mm - 20 pcs  
5m length - ø 1,50 mm - 20 pcs

7m length - ø 0,75 mm - 350 pcs  
7m length - ø 1,00 mm - 25 pcs  
7m length - ø 1,50 mm - 25 pcs

#### Light source - LED module CREE

● Warm white: 16W LED | 3000 K  
● Natural white: 16W LED | 4000 K  
○ Cool white: 16W LED | 6000 K  
● RGB: 11W LED  
● RGBW: 16W LED

#### Code

● Warm white: OS1-900-5x3-WW  
● Natural white: OS1-900-5x3-NW  
○ Cool white: OS1-900-5x3-CW  
● RGB: OS1-900-5x3-RGB  
● RGBW: OS1-900-5x3-RGBW



Complete set: 230V AC / 50-60 Hz

LED projector: 24V DC

## Complete set - 1400 optical fibers

### area 5 x 3 m

interior | SPA | Wellness | saunas  
operating temperature: - 20 to 120 °C

#### Accessories

optical fibers, LED projector OP1 - 2 pcs., power supply, glue, drills,  
RGB (RGBW) controller in case of multicolor version, paper template (optional)

#### Optical fibers

3m length - ø 0,75 mm - 200 pcs  
3m length - ø 1,00 mm - 5 pcs  
3m length - ø 1,50 mm - 5 pcs

5m length - ø 0,75 mm - 450 pcs  
5m length - ø 1,00 mm - 25 pcs  
5m length - ø 1,50 mm - 25 pcs

7m length - ø 0,75 mm - 620 pcs  
7m length - ø 1,00 mm - 35 pcs  
7m length - ø 1,50 mm - 35 pcs

#### Light source - LED module CREE

● Warm white: 2 x 16W LED | 3000 K  
● Natural white: 2 x 16W LED | 4000 K  
○ Cool white: 2 x 16W LED | 6000 K  
● RGB: 2 x 11W LED  
● RGBW: 2 x 16W LED

#### Code

● Warm white: OS1-1400-5x3-WW  
● Natural white: OS1-1400-5x3-NW  
○ Cool white: OS1-1400-5x3-CW  
● RGB: OS1-1400-5x3-RGB  
● RGBW: OS1-1400-5x3-RGBW



Complete set: 230V AC / 50-60 Hz

LED projector: 24V DC

*Note: The sets can be dimmed using external controllers. They work on the principle of low-voltage dimming.*



## LED projector OP1

Light source for optical cables

interior | SPA | Wellness  
 operating temperature: - 20 to 120 °C  
 projector temperature: 63 °C  
 material: aluminium  
 finish: black anodized

CE UKCA IP41 24V DC

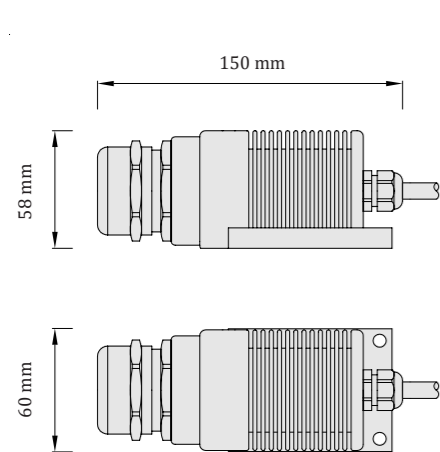

### Quantity of optical cables

Cable gland D17: max. 230 optical cables  
 Cable gland D21: max. 550 optical cables  
 Cable gland D28: max. 900 optical cables  
 in a ratio 90% : 5% : 5% (ø 0,75 mm : ø 1 mm : ø 1,5 mm)

### Light source - LED module CREE

Light source - LED module CREE	Code
● Warm white: 16W LED   3000 K	OP1-d17-WW-16W-24V
● Natural white: 16W LED   4000 K	OP1-d17-NW-16W-24V
● Cool white: 16W LED   6000 K	OP1-d17-CW-16W-24V
● RGB: 11W LED	OP1-d17-RGB-11W-24V
● RGBW: 16W LED	OP1-d17-RGBW-16W-24V

### Light source - LED module CREE

Light source - LED module CREE	Code
● Warm white: 16W LED   3000 K	OP1-d21-WW-16W-24V
● Natural white: 16W LED   4000 K	OP1-d21-NW-16W-24V
● Cool white: 16W LED   6000 K	OP1-d21-CW-16W-24V
● RGB: 11W LED	OP1-d21-RGB-11W-24V
● RGBW: 16W LED	OP1-d21-RGBW-16W-24V

### Light source - LED module CREE

Light source - LED module CREE	Code
● Warm white: 16W LED   3000 K	OP1-d28-WW-16W-24V
● Natural white: 16W LED   4000 K	OP1-d28-NW-16W-24V
● Cool white: 16W LED   6000 K	OP1-d28-CW-16W-24V
● RGB: 11W LED	OP1-d28-RGB-11W-24V
● RGBW: 16W LED	OP1-d28-RGBW-16W-24V

LED projector can be dimmed (controllable) using external controllers. It works on the principle of low-voltage dimming. Controller and power supply are not included.



## LED projector OP2

Light source for optical cables

interior | SPA | Wellness  
 operating temperature: - 20 to 120 °C  
 projector temperature: 50 °C  
 material: aluminium  
 finish: black anodized

CE UKCA IP41 12V DC

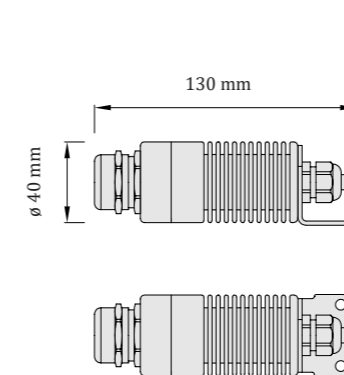

### Quantity of optical cables

Cable gland D17: max. 230 optical cables  
 Cable gland D21: max. 550 optical cables  
 in a ratio 90% : 5% : 5% (ø 0,75 mm : ø 1 mm : ø 1,5 mm)

### Light source - LED module CREE

Light source - LED module CREE	Code
● Warm white: 5W LED   3000 K	OP2-d17-WW-5W-12V
● Natural white: 5W LED   4000 K	OP2-d17-NW-5W-12V
● Cool white: 5W LED   6000 K	OP2-d17-CW-5W-12V
● RGB: 5W LED	OP2-d17-RGB-5W-12V
● RGBW: 6W LED	OP2-d17-RGBW-6W-12V

### Light source - LED module CREE

Light source - LED module CREE	Code
● Warm white: 5W LED   3000 K	OP2-d21-WW-5W-12V
● Natural white: 5W LED   4000 K	OP2-d21-NW-5W-12V
● Cool white: 5W LED   6000 K	OP2-d21-CW-5W-12V
● RGB: 5W LED	OP2-d21-RGB-5W-12V
● RGBW: 6W LED	OP2-d21-RGBW-6W-12V

LED projector can be dimmed (controllable) using external controllers. It works on the principle of low-voltage dimming. Controller and power supply are not included.



LIDES s.r.o.  
no. 1907, 951 32 Horna Kralova  
Slovakia

[www.lides.com](http://www.lides.com)  
[lides@lides.sk](mailto:lides@lides.sk)



